

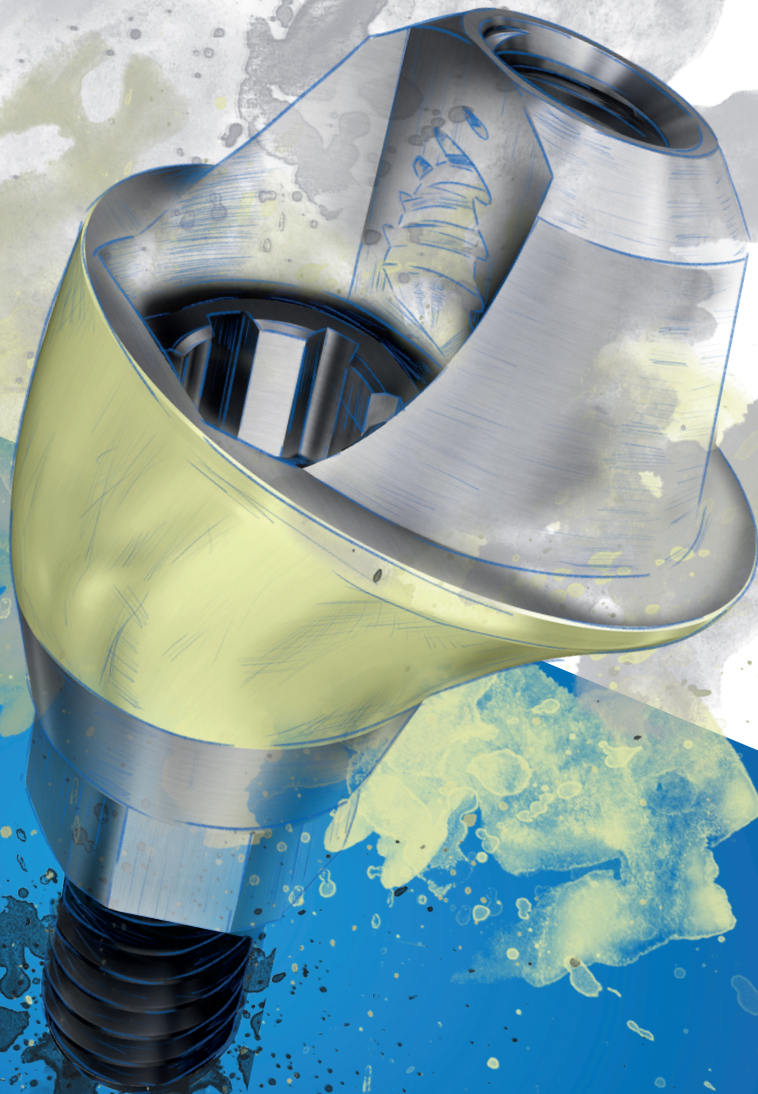

DESS







> DENTAL SMART SOLUTIONS

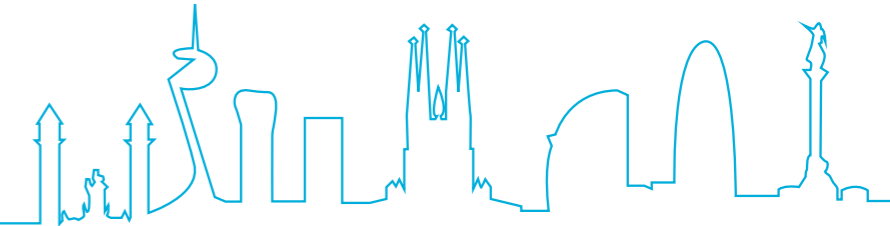





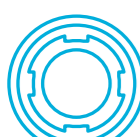
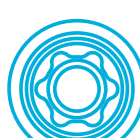

Catalogue 2024













PRODUCT LIST



	NOBELACTIVE® & NOBELREPLACE® CC ACTIVE HEX	04
	NOBEL REPLACE SELECT™ TRI-LOBE	10
	NOBEL BRÅNEMARK® EXTERNAL HEX UNIVERSAL	16
	3i OSSEOTITE® EXTERNAL HEX USA	22
	3i CERTAIN® INTERNAL HEX "CLICK"	28
	STRAUMANN® SOFT TISSUE LEVEL & synOcta® OCTAGON	34
	STRAUMANN® BONE LEVEL CONICAL BL	38
	STRAUMANN® BLX CONICAL BLX	44

	NEODENT® GRAND MORSE NEO GM	48
	ZIMMER SCREW-VENT® INTERNAL HEX USA	52
	ASTRA TECH IMPLANT SYSTEM™ EV CONIC EVO	58
	ASTRA TECH OSSEOSPEED™ INTERNAL HEX CONIC	64
	DENTSPLY FRIADENT XIVE® INTERNAL HEX FD	70
	DENTSPLY ANKYLOS® C/X INTERNAL ANK	76
	OSSTEM® TS CONIC OSS	80
	CAMLOG® INTERNAL CAM	84

	CONELOG® INTERNAL CON	88
	BIOHORIZONS® INTERNAL INTERNAL HEX BH	90
	BIOHORIZONS® EXTERNAL EXTERNAL HEX BH	94
	MIS® SEVEN INTERNAL HEX MI	96
	MIS® C1 CONIC MC	100
	MIS® V3 CONIC MV	101
	MEGAGEN AnyRidge® CONIC ANYR	102
	DENTIUM SUPERLINE™ & IMPLANTIUM® CONIC DENT	104

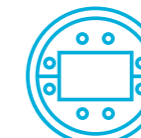
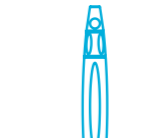
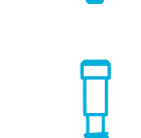
	MULTI-UNIT CONNECTION	106
	DESSLoc®	110
	DESS CLEAN FIT	112
	HOLDERS & BLOCKS	114
	TOOLS	116
	CLINICAL SCREWS FOR STRUCTURES & RECOMMENDED TORQUE	120





ACTIVE HEX

compatible with
NobelActive® / Replace® CC

○ non-engaging

⬡ engaging





HEALING ABUTMENT	3.0	NP	RP	WP
	3.0	3.5	4.3/5.0	5.5
GH 3,0mm ^A	20.068/3	20.039/3	20.040/3	20.069/3
GH 3,0mm ^B		20.047/3	20.048/3	20.070/3
GH 4,0mm ^A	20.068/4	20.039/4	20.040/4	20.069/4
GH 4,0mm ^B		20.047/4	20.048/4	20.070/4
GH 5,0mm ^A	20.068/5	20.039/5	20.040/5	20.069/5
GH 5,0mm ^B		20.047/5	20.048/5	20.070/5

^A for single crown restoration ^B for bridges and structures restoration

SCAN ABUTMENTS



	52.068	52.041	52.042	52.069
 EXTISA extender for 52.xxx.				
 52.xxx includes manual tool DTPEIPEEK.				

TRANSFER



	17.068	17.044	17.045	17.069

Transfers include two screws (for open and closed tray).



Platform Colour Coded

DIGITAL ANALOGUE

Retention screw Hex 1,27 mm 19.712-P5

3.0	NP	RP	WP
3.0	3.5	4.3/5.0	5.5
14.068/D	14.041/D	14.042/D	14.069/D



Platform Colour Coded

ANALOGUE

10 Pack.

14.068	14.041	14.042	14.069
	14.041-P10	14.042-P10	14.069-P10



TEMPORARY ABUTMENT

○	24.068	24.041	24.042	24.069
⬡	25.068	25.041	25.042	25.069

DESSLoc®

GH 1,0mm	88.039/1	88.040/1
GH 2,0mm	88.039/2	88.040/2
GH 3,0mm	88.039/3	88.040/3
GH 4,0mm	88.039/4	88.040/4





MULTI-UNIT ABUTMENTS

		3.0	NP	RP	WP
		3.0	3.5	4.3/5.0	5.5
GH 1,5mm	0°		40.007/1	40.008/1	
GH 2,5mm	0°		40.007/2	40.008/2	
GH 3,5mm	0°		40.007/3	40.008/3	
GH 4,5mm	0°			40.008/4	
GH 2,5mm	17°		41.707/2	41.708/2	
GH 3,5mm	17°		41.707/3	41.708/3	
GH 3,5mm	30°		43.007/3	43.008/3	
GH 4,5mm	30°		43.007/4	43.008/4	

4.8
MULTI-UNIT PLATFORM

NEW MUA+



GH 1,5mm	0°		42.404/1	42.405/1	
GH 2,5mm	0°		42.404/2	42.405/2	
GH 3,5mm	0°		42.404/3	42.405/3	
GH 4,5mm	0°			42.405/4	
GH 2,5mm	17°		46.404/2	46.405/2	
GH 3,5mm	17°		46.404/3	46.405/3	
GH 3,5mm	30°		47.404/3	47.405/3	
GH 4,5mm	30°		47.404/4	47.405/4	

4.8
MULTI-UNIT PLATFORM



TI-BASE

		3.0	NP	RP	WP
		3.0	3.5	4.3/5.0	5.5
GH 1,2mm	○			15.042	
GH 1,5mm	○	NEW 15.468	NEW 15.441		15.069
GH 2,0mm	○			15.042/2	
GH 3,0mm	○			15.342	
GH 1,2mm	⬡			16.042	
GH 1,5mm	⬡	NEW 16.468	NEW 16.441		16.069
GH 2,0mm	⬡			16.042/2	
GH 3,0mm	⬡			16.342	

TI-BASE CASTABLES



5 Pack.	○			32.001-P5	32.001-P5
5 Pack.	⬡			33.001-P5	33.001-P5

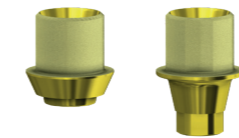

ANGLEBase®

○		36.041	36.042
⬡		37.041	37.042

PLASTIC SLEEVES FOR ANGLEBase®



5 Pack.	0°	33.100-P5	33.100-P5
5 Pack.	10°	33.101-P5	33.101-P5
5 Pack.	20°	33.102-P5	33.102-P5

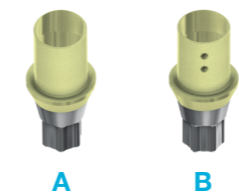



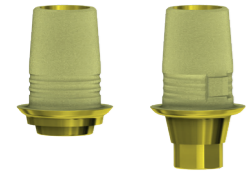

ELLIPTIBase®

A corner	⬡	56.068
B flat	⬡	57.068



C-Base®

		3.0	NP	RP	WP
		3.0	3.5	4.3/5.0	5.5
GH 0,8mm			58.041	58.042	
GH 3,0mm			58.041/3	58.042/3	
GH 0,8mm			59.041	59.042	
GH 3,0mm			59.041/3	59.042/3	

Includes screw, same as standard screw.

Libraries available for EXOCAD & 3Shape.

**Torx® Screw
ANGLEBase® & ELLIPTIBase® & ASC BLANK**



(replacement screw)	3.0	NP	RP	WP
	19.468	19.441	19.442	
Recommended torque	15 Ncm	35 Ncm	35 Ncm	

Torx® BALL SCREWDRIVER



	20mm	24mm	30mm	35mm
	DT20TB06	DT24TB06	DT30TB06	DT35TB06

ABUTMENTS



	0°	NP	RP	WP
		13.041	13.042	

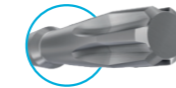





SCREW UG

	3.0	NP	RP	WP
	3.0	3.5	4.3/5.0	5.5
	19.068	19.027	19.030	19.030
10 Pack.		19.027-P10	19.030-P10	19.030-P10
DLC		19.227	19.230	19.230
Recommended torque	15 Ncm	35 Ncm	35 Ncm	35 Ncm

PRE-MILLED BLANK

Ø 10mm	Ti	61.068	61.041	61.042	61.069
Ø 14mm	Ti		62.041	62.042	62.069
Ø 14mm	CoCr		71.041		71.069

**NEW
ASC BLANK**

Ø 10mm	Ti	A corner		61.349	
Ø 10mm	Ti	B flat		71.349	
Ø 14mm	Ti	A corner			61.341 61.342
Ø 14mm	Ti	B flat			71.341 71.342

CoCr BASE

		30.041	30.042
		31.041	31.042

CASTABLE

		28.041	28.042
		29.041	29.042



TRI-LOBE

compatible with
NobelReplace Select™

○ non-engaging

◁ engaging



HEALING ABUTMENT

	NP	RP	WP	6.0
	NP/3.5	RP/4.3	WP/5.0	6.0
GH 3,0mm	20.004/3	20.005/3	20.006/3	
GH 4,0mm	20.004/4	20.005/4	20.006/4	
GH 5,0mm	20.004/5	20.005/5	20.006/5	



SCAN ABUTMENTS

	NP	RP	WP	6.0
	52.004	52.005	52.006	52.097



EXTISA extender for 52.xxx.



52.xxx includes manual tool DTPEIPEEK.



TRANSFER

	NP	RP	WP	6.0
	17.004	17.005	17.006	17.097

Transfers include two screws (for open and closed tray).



Platform Colour Coded

DIGITAL ANALOGUE

Retention screw Hex 1,27 mm 19.712-P5	NP	RP	WP	6.0
	14.004/D	14.005/D	14.006/D	14.097/D



Platform Colour Coded

ANALOGUE

	NP	RP	WP	6.0
	NP/3.5	RP/4.3	WP/5.0	6.0
	14.004	14.005	14.006	14.097
10 Pack.	14.004-P10	14.005-P10		



TEMPORARY ABUTMENT

	NP	RP	WP
○	24.004	24.005	24.006
◁	25.004	25.005	25.006



DESSLoc®

GH 1,0mm	88.004/1	88.005/1
GH 2,0mm	88.004/2	88.005/2
GH 3,0mm	88.004/3	88.005/3
GH 4,0mm	88.004/4	88.005/4



MULTI-UNIT ABUTMENTS			NP	RP	WP	6.0
			NP/3.5	RP/4.3	WP/5.0	6.0
GH 1,0mm	0°	○	40.004/1	40.005/1	40.006/1	
GH 2,0mm	0°	○	40.004/2	40.005/2	40.006/2	
GH 3,0mm	0°	○	40.004/3	40.005/3	40.006/3	
GH 4,0mm	0°	○		40.005/4		
GH 5,0mm	0°	○		40.005/5		
GH 2,0mm	17°	◁	41.704/2	41.705/2		
GH 3,0mm	17°	◁	41.704/3	41.705/3		
GH 4,0mm	17°	◁		41.705/4		
GH 4,0mm	30°	◁		43.005/4		
GH 5,0mm	30°	◁		43.005/5		

4.8
MULTI-UNIT PLATFORM



TI-BASE						
GH 0,3mm		○	15.004	15.005	15.006	15.097
GH 1,5mm		○	15.204	15.205	15.206	
GH 3,0mm		○	15.304	15.305	15.306	
GH 0,3mm		◁	16.004	16.005	16.006	16.097
GH 1,5mm		◁	16.204	16.205		
GH 3,0mm		◁	16.304	16.305		



TI-BASE CASTABLES						
5 Pack.		○	32.001-P5	32.001-P5	32.001-P5	32.001-P5
5 Pack.		◁	33.001-P5	33.001-P5	33.001-P5	33.001-P5

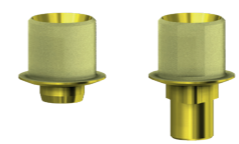

ANGLEBase®		NP	RP	WP	6.0
		NP/3.5	RP/4.3	WP/5.0	6.0
	○	36.004	36.005	36.006	
	◁	37.004	37.005	37.006	



PLASTIC SLEEVES FOR ANGLEBase®						
5 Pack.	0°	33.100-P5	33.100-P5	33.100-P5		
5 Pack.	10°	33.101-P5	33.101-P5	33.101-P5		
5 Pack.	20°	33.102-P5	33.102-P5	33.102-P5		

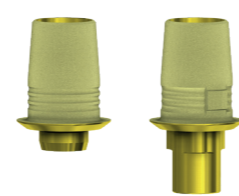

C-Base®						
GH 0,4mm		○	58.004		58.006	58.097
GH 0,5mm		○		58.005		
GH 1,5mm		○	58.004/2	58.005/2	58.006/2	
GH 3,0mm		○	58.004/3	58.005/3	58.006/3	
GH 0,4mm		◁	59.004		59.006	59.097
GH 0,5mm		◁		59.005		
GH 1,5mm		◁	59.004/2	59.005/2	59.006/2	
GH 3,0mm		◁	59.004/3	59.005/3	59.006/3	

Includes screw, same as standard screw.

Libraries available for EXOCAD & 3Shape.



Torx® Screw ANGLEBase®				
(replacement screw)		19.404	19.405	19.405
Recommended torque		35 Ncm	35 Ncm	35 Ncm



Torx® BALL SCREWDRIVER				
	20mm	24mm	30mm	35mm
	DT20TB06	DT24TB06	DT30TB06	DT35TB06



ABUTMENTS

	NP	RP	WP	6.0
	NP/3.5	RP/4.3	WP/5.0	6.0
0°	13.004	13.005	13.006	



SCREW UG

	19.004	19.005	19.005	19.005
10 Pack.	19.004-P10	19.005-P10	19.005-P10	19.005-P10
DLC	19.204	19.205	19.205	19.205
<i>Recommended torque</i>	<i>35 Ncm</i>	<i>35 Ncm</i>	<i>35 Ncm</i>	<i>35 Ncm</i>

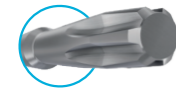

PRE-MILLED BLANK

Ø 10mm	Ti	61.004	61.005	61.006	61.097
Ø 14mm	Ti		62.005	62.006	62.097
Ø 14mm	CoCr	71.004	71.005	71.006	71.097

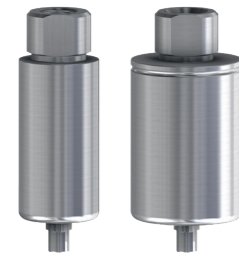

CoCr BASE

○	30.004	30.005	30.006
◊	31.004	31.005	31.006



CASTABLE

○	28.004	28.005	28.006
◊	29.004	29.005	29.006



“Great things are done by a series of small things brought together”

A business without quality will not last. Terrats Medical is in its third generation and we want to honour our heritage with the highest requirements for quality in all we do.



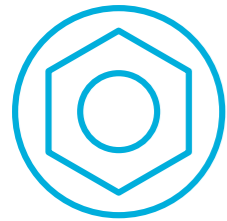

EXTERNAL HEX UNIVERSAL

compatible with
Nobel Brånemark®

-  non-engaging
-  engaging



HEALING ABUTMENT

	NP	RP	WP
	NP/3.5	RP/4.1	WP/5.1
GH 3,0mm	20.001/3	20.002/3	20.003/3
GH 4,0mm	20.001/4	20.002/4	20.003/4
GH 5,0mm	20.001/5	20.002/5	20.003/5



SCAN ABUTMENTS

	NP	RP	WP
	52.001	52.002	52.003



EXTISA extender for 52.xxx.



52.xxx includes manual tool DTPEIPEEK.



TRANSFER

	NP	RP	WP
	17.041	17.042	17.043

Transfers include two screws (for open and closed tray).



Platform Colour Coded

DIGITAL ANALOGUE

Retention screw Hex 1,27 mm 19.712-P5



Platform Colour Coded

ANALOGUE

10 Pack.

	NP	RP	WP
	NP/3.5	RP/4.1	WP/5.1
	14.001/D	14.002/D	14.003/D

	14.001	14.002	14.003
		14.002-P10	

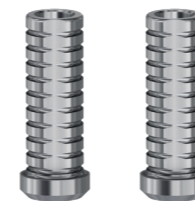

TEMPORARY ABUTMENT



	24.001	24.002	24.003
--	--------	--------	--------



	25.001	25.002	25.003
--	--------	--------	--------

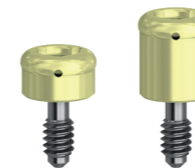

DESSLoc®

GH 1,0mm	88.001/1	88.002/1
GH 2,0mm	88.001/2	88.002/2
GH 3,0mm	88.001/3	88.002/3
GH 4,0mm		88.002/4
GH 5,0mm		88.002/5



MULTI-UNIT ABUTMENTS

			NP	RP	WP
			NP/3.5	RP/4.1	WP/5.1
GH 1,0mm	0°	○	40.001/1	40.002/1	40.003/1
GH 2,0mm	0°	○	40.001/2	40.002/2	40.003/2
GH 3,0mm	0°	○	40.001/3	40.002/3	40.003/3
GH 4,0mm	0°	○		40.002/4	
GH 5,0mm	0°	○		40.002/5	

4.8 | 6.5
MULTI-UNIT PLATFORM

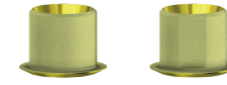

TI-BASE

GH 0,3mm	○	15.001	15.002	15.003
GH 1,5mm	○	15.201	15.202	15.203
GH 3,0mm	○	15.301	15.302	15.303
GH 0,3mm	⬡	16.001	16.002	16.003
GH 1,5mm	⬡	16.201	16.202	16.203
GH 3,0mm	⬡	16.301	16.302	16.303

TI-BASE CASTABLES

5 Pack.	○	32.001-P5	32.001-P5	32.003-P5
5 Pack.	⬡	33.001-P5	33.001-P5	33.003-P5



ANGLEBase®

		NP	RP	WP
		NP/3.5	RP/4.1	WP/5.1
GH 0,3mm	○	36.001	36.002	
GH 1,5mm	○	36.001/2	36.002/2	
GH 2,5mm	○	36.001/3	36.002/3	
GH 0,3mm	⬡	37.001	37.002	
GH 1,5mm	⬡	37.001/2	37.002/2	
GH 2,5mm	⬡	37.001/3	37.002/3	

PLASTIC SLEEVES FOR ANGLEBase®



5 Pack.	0°	33.100-P5	33.100-P5
5 Pack.	10°	33.101-P5	33.101-P5
5 Pack.	20°	33.102-P5	33.102-P5

C-Base®

GH 1,5mm	○	58.001/2	58.002/2
GH 3,0mm	○	58.001/3	58.002/3
GH 0,6mm	⬡	59.001	59.002
GH 1,5mm	⬡	59.001/2	59.002/2
GH 3,0mm	⬡	59.001/3	59.002/3

Includes screw, same as standard screw.

Libraries available for EXOCAD & 3Shape.

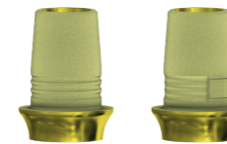

Torx® Screw ANGLEBase®

(replacement screw)

Recommended torque

19.401	19.402
35 Ncm	35 Ncm



Torx® BALL SCREWDRIVER

	20mm	24mm	30mm	35mm
	DT20TB06	DT24TB06	DT30TB06	DT35TB06





ABUTMENTS

		NP	RP	WP
		NP/3.5	RP/4.1	WP/5.1
	0°	13.001	13.002	13.003



SCREW UG

		19.027	19.028	19.029
	10 Pack.	19.027-P10	19.028-P10	
	DLC	19.227	19.228	19.229
<i>Recommended torque</i>		<i>35 Ncm</i>	<i>35 Ncm</i>	<i>35 Ncm</i>

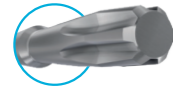

PRE-MILLED BLANK

Ø 10mm	Ti	61.001	61.002	61.003
Ø 14mm	CoCr	71.001	71.002	71.003



CoCr BASE

	○	30.001	30.002	30.003
	⬡	31.001	31.002	31.003



CASTABLE

	○	28.001	28.002	28.003
	⬡	29.001	29.002	29.003

“The difference between something good and something exceptional is in the smallest detail”

At DESS® we believe that no detail is too small to escape close attention. That’s why our exhaustive quality controls in every single part of the manufacturing process ensure that the quality of our products is guaranteed. Our confidence is such that we offer a lifetime warranty on all our products.



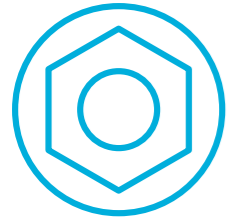

EXTERNAL HEX USA

compatible with
3i® Osseotite®

○ non-engaging

⬡ engaging



HEALING ABUTMENT

	NP	RP	WP
	3.4	4.1	5.0
GH 3,0mm	20.011/3	20.012/3	20.013/3
GH 4,0mm	20.011/4	20.012/4	20.013/4
GH 5,0mm	20.011/5	20.012/5	20.013/5



SCAN ABUTMENTS

	NP	RP	WP
	52.011	52.012	52.013



EXTISA extender for 52.xxx.



52.xxx includes manual tool DTPEIPEEK.



TRANSFER

	NP	RP	WP
	17.011	17.012	17.013

Transfers include two screws (for open and closed tray).



DIGITAL ANALOGUE

Retention screw Hex 1,27 mm 19.712-P5

Platform Colour Coded



ANALOGUE

Platform Colour Coded

10 Pack.

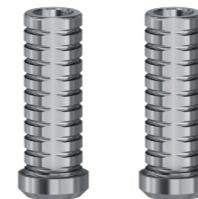

TEMPORARY ABUTMENT



24.011 24.012 24.013



25.011 25.012 25.013

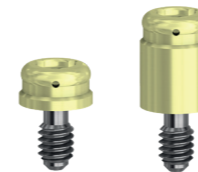











DESSLoc®

GH 1,0mm	88.011/1	88.012/1	88.013/1
GH 2,0mm	88.011/2	88.012/2	88.013/2
GH 3,0mm	88.011/3	88.012/3	88.013/3
GH 4,0mm	88.011/4	88.012/4	88.013/4
GH 5,0mm	88.011/5	88.012/5	88.013/5
GH 6,0mm	88.011/6 FDA & Canada only		88.013/6 FDA & Canada only







MULTI-UNIT ABUTMENTS

NP	RP	WP
3.4	4.1	5.0



GH 1,0mm	0°		40.009/1	40.017/1	
GH 2,0mm	0°		40.009/2	40.017/2	
GH 3,0mm	0°		40.009/3	40.017/3	
GH 4,0mm	0°			40.017/4	
GH 5,0mm	0°			40.017/5	
GH 2,0mm	17°			41.712/2	
GH 3,0mm	17°			41.712/3	
GH 4,0mm	17°			41.712/4	
GH 3,0mm	30°			43.012/3	
GH 4,0mm	30°			43.012/4	
GH 5,0mm	30°			43.012/5	

4.8
MULTI-UNIT PLATFORM

TI-BASE

GH 0,3mm		15.011	15.012	15.013
GH 1,5mm		15.211	15.212	15.213
GH 3,0mm		15.311	15.312	15.313
GH 0,3mm		16.011	16.012	16.013
GH 1,5mm		16.211	16.212	16.213
GH 3,0mm		16.311	16.312	16.313







TI-BASE CASTABLES

5 Pack.		32.001-P5	32.001-P5	32.001-P5
5 Pack.		33.001-P5	33.001-P5	33.001-P5



ANGLEBase®

NP	RP	WP
3.4	4.1	5.0





GH 0,3mm		36.011	36.012	36.013
GH 1,5mm		36.011/2	36.012/2	
GH 2,5mm		36.011/3	36.012/3	
GH 0,3mm		37.011	37.012	37.013
GH 1,5mm		37.011/2	37.012/2	
GH 2,5mm		37.011/3	37.012/3	

PLASTIC SLEEVES FOR ANGLEBase®



5 Pack.	0°	33.100-P5	33.100-P5	33.100-P5
5 Pack.	10°	33.101-P5	33.101-P5	33.101-P5
5 Pack.	20°	33.102-P5	33.102-P5	33.102-P5

C-Base®

GH 1,5mm		58.011/2	58.012/2	58.013/2
GH 3,0mm		58.011/3	58.012/3	58.013/3
GH 0,6mm		59.011	59.012	59.013
GH 1,5mm		59.011/2	59.012/2	59.013/2
GH 3,0mm		59.011/3	59.012/3	59.013/3

Includes screw, same as standard screw.

Libraries available for EXOCAD & 3Shape.

Torx® Screw ANGLEBase®

(replacement screw)

Recommended torque

19.402	19.402	19.402
20 Ncm	20 Ncm	20 Ncm

Torx® BALL SCREWDRIVER

	20mm	24mm	30mm	35mm
	DT20TB06	DT24TB06	DT30TB06	DT35TB06

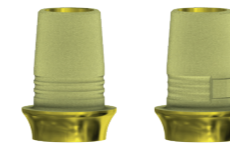
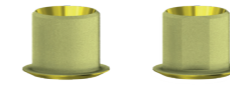

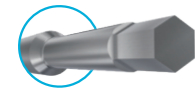

		NP	RP	WP
		3.4	4.1	5.0
ABUTMENTS	0°	13.011	13.012	13.013

SCREW HEX 1,20mm

		19.034	19.034	19.034
	10 Pack.	19.034-P10	19.034-P10	19.034-P10
	<i>Recommended torque</i>	<i>20 Ncm</i>	<i>20 Ncm</i>	<i>20 Ncm</i>

PRE-MILLED BLANK

Ø 10mm	Ti	61.011	61.012	61.013
Ø 14mm	CoCr	71.011	71.012	71.013

CoCr BASE

	○	30.011	30.012	30.013
	⬡	31.011	31.012	31.013

CASTABLE

	○	28.011	28.012	28.013
	⬡	29.011	29.012	29.013

“There is no good idea that cannot be improved”

We are proud to say that innovation and quality are at the center of our core values. We look at different solutions and re-engineer them to provide better and more reliable alternatives. Products like our intra-oral scan abutment without a screw hole, which improves substantially the image precision, our angled Multi-unit abutment with a fully shaped connection and vertical access for more stability and less screw loosening or our angled screw channel solution ANGLEBase® that allows you 25° angle with a 360° rotation, are clear examples of our way of doing things.





INTERNAL HEX "CLICK"

compatible with
3i Certain®

-  non-engaging
-  engaging



HEALING ABUTMENT

	NP	RP	WP
	3.4	4.1	5.0
GH 3,0mm	20.014/3	20.015/3	20.016/3
GH 4,0mm	20.014/4	20.015/4	20.016/4
GH 5,0mm	20.014/5	20.015/5	20.016/5



SCAN ABUTMENTS

	NP	RP	WP
	52.014	52.015	52.016



EXTISA extender for 52.xxx.



52.xxx includes manual tool DTPEIPEEK.



TRANSFER

	NP	RP	WP
	17.014	17.015	17.016

Transfers include two screws (for open and closed tray).



Platform Colour Coded

DIGITAL ANALOGUE

Retention screw Hex 1,27 mm 19.712-P5



Platform Colour Coded

ANALOGUE

	NP	RP	WP
	14.014/D	14.015/D	14.016/D
	14.014	14.015	14.016
		14.015-P10	

10 Pack.



TEMPORARY ABUTMENT

	NP	RP	WP
	24.014	24.015	24.016
	25.014	25.015	25.016



DESSLoc®

GH 1,0mm	88.014/1	88.015/1	88.016/1
GH 2,0mm	88.014/2	88.015/2	88.016/2
GH 3,0mm	88.014/3	88.015/3	88.016/3
GH 4,0mm	88.014/4	88.015/4	88.016/4
GH 5,0mm	88.014/5	88.015/5	88.016/5
GH 6,0mm	88.014/6 FDA & Canada only	88.015/6 FDA & Canada only	88.016/6 FDA & Canada only



TI-BASE

		NP	RP	WP
		3.4	4.1	5.0
GH 0,3mm	○	15.014	15.015	15.016
GH 1,5mm	○	15.214	15.215	15.216
GH 3,0mm	○	15.314	15.315	15.316
GH 0,3mm	⬡	16.014	16.015	16.016
GH 1,5mm	⬡	16.214	16.215	16.216
GH 3,0mm	⬡	16.314	16.315	16.316



TI-BASE CASTABLES

5 Pack.	○	32.001-P5	32.001-P5	32.001-P5
5 Pack.	⬡	33.001-P5	33.001-P5	33.001-P5

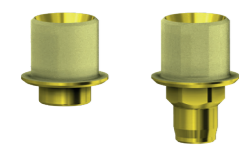

ANGLEBase®

	○	36.014	36.015	36.016
	⬡	37.014	37.015	37.016

PLASTIC SLEEVES FOR ANGLEBase®

5 Pack.	0°	33.100-P5	33.100-P5	33.100-P5
5 Pack.	10°	33.101-P5	33.101-P5	33.101-P5
5 Pack.	20°	33.102-P5	33.102-P5	33.102-P5

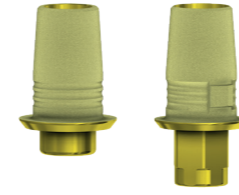

C-Base®

		NP	RP	WP
		3.4	4.1	5.0
GH 0,4mm	○	58.014	58.015	
GH 0,5mm	○			58.016
GH 1,5mm	○	58.014/2	58.015/2	58.016/2
GH 3,0mm	○	58.014/3	58.015/3	58.016/3
GH 0,4mm	⬡	59.014	59.015	
GH 0,5mm	⬡			59.016
GH 1,5mm	⬡	59.014/2	59.015/2	59.016/2
GH 3,0mm	⬡	59.014/3	59.015/3	59.016/3

Includes screw, same as standard screw.

Libraries available for EXOCAD & 3Shape.



Torx® Screw ANGLEBase®

(replacement screw)	19.438	19.438	19.438
Recommended torque	20 Ncm	20 Ncm	20 Ncm



Torx® BALL SCREWDRIVER

	20mm	24mm	30mm	35mm
	DT20TB06	DT24TB06	DT30TB06	DT35TB06



ABUTMENTS

0°	13.014	13.015	13.016
----	--------	--------	--------

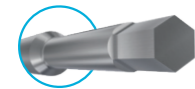

SCREW HEX 1,20mm

	NP	RP	WP
	3.4	4.1	5.0
	19.011	19.011	19.011
10 Pack.	19.011-P10	19.011-P10	19.011-P10
<i>Recommended torque</i>	<i>20 Ncm</i>	<i>20 Ncm</i>	<i>20 Ncm</i>





PRE-MILLED BLANK

Ø 10mm	Ti	61.014	61.015	61.016
Ø 14mm	Ti		62.015	62.016
Ø 14mm	CoCr			71.016



CoCr BASE

	30.014	30.015	30.016
	31.014	31.015	31.016



CASTABLE

	28.014	28.015	28.016
	29.014	29.015	29.016

SelectGrip®

Maximum Precision & Retention

DESS® SelectGrip® Surface offers 500% more bonding retention than an untreated surface. This is achieved through a sandblasting treatment applied during the manufacturing procedure, resulting in a flawless finish without risk for damages to critical surfaces that also preserves a clean gingival area, an achievement almost impossible to get in a laboratory manual procedure.



Flawless finish

Preserves a clean gingival area

Almost impossible to get in a laboratory manual procedure

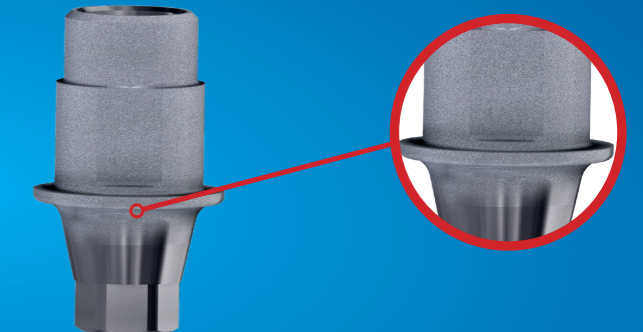

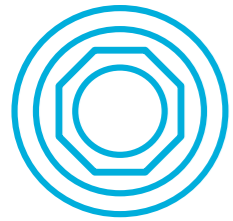

OCTAGON

compatible with
Straumann® Tissue level & synOcta®

○ non-engaging

○ engaging



HEALING ABUTMENT

	NNC	RN	WN
	3.5	4.1/4.8	4.8/6.5
GH 2,0mm		20.009/2	20.045/2
GH 3,0mm		20.009/3	20.045/3
GH 4,0mm		20.009/4	20.045/4
On abutment		20.010	20.049



CONVERTER ABUTMENT

	○	35.001	
	○	34.001	34.002



SCAN ABUTMENTS

	52.070	52.009	52.045
On abutment		52.010	52.048

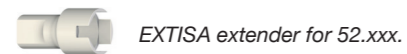

TRANSFER

	17.070	17.009	17.053
On abutment		17.010	17.048

Transfers include two screws (for open and closed tray).



DIGITAL ANALOGUE

Retention screw Hex 1,27 mm 19.712-P5	14.070/D	14.009/D	14.045/D
On abutment		14.010/D	14.046/D

Platform Colour Coded



ANALOGUE

	NNC	RN	WN
	3.5	4.1/4.8	4.8/6.5
	14.070	14.009	14.045
10 Pack.		14.009-P10	
On abutment		14.010	14.046



TEMPORARY ABUTMENT

	○	24.026	24.045
	○	25.009	25.045
On abutment	○	24.010	24.047
	○	25.026	25.047

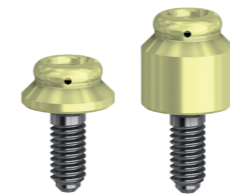

DESSLoc®

GH 1,0mm	88.009/1
GH 2,0mm	88.009/2
GH 3,0mm	88.009/3
GH 4,0mm	88.009/4

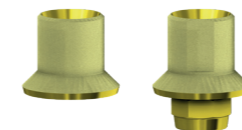

ANGLEBase®

	○	36.046	36.047
	○	37.009	37.045

PLASTIC SLEEVES FOR ANGLEBase®

5 Pack.	0°	33.200-P5	33.300-P5
5 Pack.	10°	33.201-P5	33.301-P5
5 Pack.	20°	33.202-P5	33.302-P5

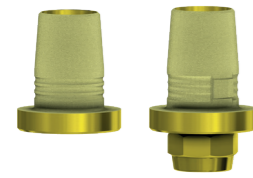



C-Base®

GH 1,0mm	
GH 1,2mm	
GH 1,0mm	
GH 1,2mm	

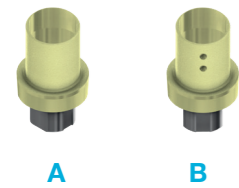
Includes screw, same as standard screw.



ELLIPTIBase®

A corner	
B flat	

Torx® Screw
ANGLEBase® & ELLIPTIBase®











(replacement screw)

Recommended torque







TI-BASE

		3.5	4.1/4.8	4.8/6.5
GH 0,3mm				15.045
GH 0,4mm			15.046	
GH 0,5mm		15.070		
GH 0,3mm				16.045
GH 0,4mm			16.009	
GH 0,5mm		16.070		
On abutment GH 0,3mm			15.010	15.048
GH 0,3mm			16.010	16.048



TI-BASE CASTABLES

		3.5	4.1/4.8	4.8/6.5
5 Pack.		32.001-P5	32.046-P5	32.045-P5
5 Pack.		33.001-P5	33.009-P5	33.045-P5
On abutment 5 Pack.			32.010-P5	32.045-P5
5 Pack.			33.010-P5	33.045-P5

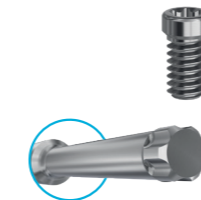

ABUTMENTS

	3.5	4.1/4.8	4.8/6.5
0°		13.009	

**inc.captive screw*

SCREW TORX®

	3.5	4.1/4.8	4.8/6.5
10 Pack.	19.070	19.026	19.026
		19.026-P10	19.026-P10
<i>Recommended torque</i>	35 Ncm	35 Ncm	35 Ncm





On abutment

Recommended torque





PRE-MILLED BLANK

Ø 10mm	Ti	61.070	61.009	61.045
Ø 14mm	Ti		62.009	62.045
Ø 14mm	CoCr	71.070		

CoCr BASE

		30.009	30.045
		31.009	31.045
On abutment		30.010	30.048
		31.010	31.048

CASTABLE

			28.045
		29.009	29.045
On abutment		28.010	28.046
On abutment		29.010	29.046

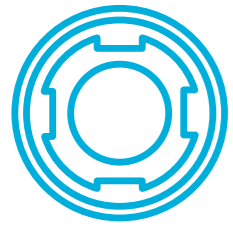

CONICAL BL

compatible with
Straumann® Bone level

○ non-engaging
◻ engaging



HEALING ABUTMENT

	NP	RP	NP/RP
	NC/3.3	RC/4.1-4.8	NC/RC
GH 3,0mm	20.041/3	20.042/3	
GH 4,0mm	20.041/4	20.042/4	
GH 5,0mm	20.041/5	20.042/5	



SCAN ABUTMENTS

	NP	RP	NP/RP
52.043	52.043	52.044	
On abutment SRA			52.098



EXTISA extender for 52.xxx.



52.xxx includes manual tool DTPEIPEEK.



TRANSFER

	NP	RP	NP/RP
	17.046	17.047	
Transfers include two screws (for open and closed tray).			



DIGITAL ANALOGUE

Retention screw Hex 1,27 mm 19.712-P5

OF SRA

4,6 Ø

	NP	RP	NP/RP
	NC/3.3	RC/4.1-4.8	NC/RC
	14.043/D	14.044/D	
			14.098/D

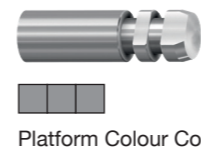

ANALOGUE

OF SRA

4,6 Ø

	NP	RP	NP/RP
	14.043	14.044	
10 Pack.	14.043-P10	14.044-P10	
			14.098



TEMPORARY ABUTMENT

On abutment SRA

4,6 Ø

	NP	RP	NP/RP
○	24.043	24.044	
◻	25.043	25.044	
○			24.098
◻			25.098











DESSLoc®

GH 1,0mm		88.042/1
GH 2,0mm	88.041/2	88.042/2
GH 3,0mm	88.041/3	88.042/3
GH 4,0mm	88.041/4	88.042/4



MULTI-UNIT ABUTMENTS









				NP	RP	NP/RP
				NC/3.3	RC/4.1-4.8	NC/RC
GH 1,5mm	0°			40.043/1	40.044/1	
GH 2,5mm	0°			40.043/2	40.044/2	
GH 3,5mm	0°			40.043/3	40.044/3	
GH 4,5mm	0°				40.044/4	
GH 2,5mm	17°			41.743/2	41.744/2	
GH 3,5mm	17°			41.743/3	41.744/3	
GH 3,5mm	30°			43.043/3	43.044/3	
GH 4,5mm	30°			43.043/4	43.044/4	

4.8
MULTI-UNIT PLATFORM

NEW MUA+













A

GH 1,5mm	0°			42.443/1	42.444/1	
GH 2,5mm	0°			42.443/2	42.444/2	
GH 3,5mm	0°			42.443/3	42.444/3	
GH 4,5mm	0°				42.444/4	
A corner	GH 2,5mm	17°		46.443/2	46.444/2	
A corner	GH 3,5mm	17°		46.443/3	46.444/3	
A corner	GH 3,5mm	30°		47.443/3	47.444/3	
A corner	GH 4,5mm	30°		47.443/4	47.444/4	

4.8
MULTI-UNIT PLATFORM



TI-BASE

			NP	RP	NP/RP
			NC/3.3	RC/4.1-4.8	NC/RC
GH 1,2mm				15.044	
GH 1,5mm				15.443	
GH 2,0mm				15.044/2	
GH 3,0mm				15.344	
GH 1,2mm				16.044	
GH 1,5mm				16.443	
GH 2,0mm				16.044/2	
GH 3,0mm				16.344	





ON SRA

4,6 Ø				15.098
				16.098

TI-BASE CASTABLES





ON SRA

5 Pack.				32.001-P5
5 Pack.				33.001-P5
4,6 Ø / 5 Pack.				32.098-P5
5 Pack.				33.098-P5

ANGLEBase®



			36.043	36.044
			37.043	37.044





PLASTIC SLEEVES FOR ANGLEBase®

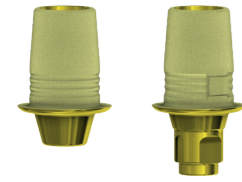

5 Pack.	0°		33.100-P5	33.100-P5
5 Pack.	10°		33.101-P5	33.101-P5
5 Pack.	20°		33.102-P5	33.102-P5



C-Base®

		NP	RP	NP/RP
		NC/3.3	RC/4.1-4.8	NC/RC
GH 0,7mm			58.044	
GH 3,0mm		58.043/3	58.044/3	
GH 0,7mm		59.043	59.044	
GH 3,0mm		59.043/3	59.044/3	

Includes screw, same as standard screw.

Libraries available for EXOCAD & 3Shape.

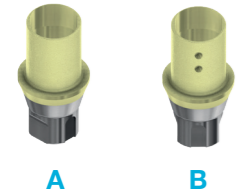

ELLIPTIBase®

A corner		56.043		
B flat		57.043		

Torx® Screw
ANGLEBase® & ELLIPTIBase® & ASC BLANK



(replacement screw)	19.443	19.443		
Recommended torque	35 Ncm	35 Ncm		

Torx® BALL SCREWDRIVER 20mm 24mm 30mm 35mm



DT20TB06	DT24TB06	DT30TB06	DT35TB06
----------	----------	----------	----------

ABUTMENTS



0°	13.043	13.044		
----	--------	--------	--	--



A B



SCREW TORX®

		NP	RP	NP/RP
		NC/3.3	RC/4.1-4.8	NC/RC
		19.032	19.033	19.037
10 Pack.		19.032-P10	19.033-P10	19.037-P10
Recommended torque		35 Ncm	35 Ncm	35 Ncm
On abutment SRA	4,6 Ø			19.098
10 Pack.				19.098-P10
Recommended torque				15 Ncm



PRE-MILLED BLANK

Ø 10mm	Ti	61.043	61.044
Ø 14mm	Ti	62.043	62.044
Ø 14mm	CoCr		71.044

NEW
ASC BLANK

Ø 14mm	Ti	A corner		61.343	61.344
Ø 14mm	Ti	B flat		71.343	71.344

CoCr BASE

		30.043	30.044	
		31.043	31.044	
On abutment SRA	4,6 Ø			30.098
				31.098

CASTABLE

		28.043	28.044
		29.043	29.044



CONICAL BLX

compatible with
Straumann® BLX

-  non-engaging
-  engaging

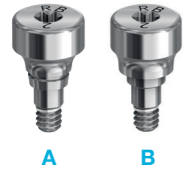



HEALING ABUTMENT

	RB/WB	WB
	3.5	4.5
GH 0,8mm ^{A/B}		20.463/1
GH 1,5mm ^A	20.461/2	20.461/2
GH 1,5mm ^B	20.462/2	20.462/2
GH 1,5mm ^{A/B}		20.463/2
GH 2,5mm ^A	20.461/3	20.461/3
GH 2,5mm ^B	20.462/3	20.462/3
GH 3,5mm ^A	20.461/4	20.461/4
GH 3,5mm ^B	20.462/4	20.462/4

^Afor single crown restoration ^Bfor bridges and structures restorations

SCAN ABUTMENTS



	RB/WB	WB
	52.062	52.062
On abutment SRA		52.098
 EXTISA extender for 52.xxx.		
 52.xxx includes manual tool DTPEIPEEK.		

TRANSFER



	RB/WB	WB
	17.062	17.062

Transfers include two screws (for open and closed tray).



 Platform Colour Coded

DIGITAL ANALOGUE

Retention screw Hex 1,27 mm 19.712-P5

	RB/WB	WB
	3.5	4.5
OF SRA	4,6 Ø	14.062/D 14.063/D
		14.098/D



 Platform Colour Coded

ANALOGUE

	RB/WB	WB
	14.062	14.063
OF SRA	4,6 Ø	14.098











MULTI-UNIT ABUTMENTS

GH 1,5mm	0°		40.062/1	40.062/1
GH 2,5mm	0°		40.062/2	40.062/2
GH 3,5mm	0°		40.062/3	40.062/3
GH 2,5mm	17°		41.762/2	41.762/2
GH 3,5mm	17°		41.762/3	41.762/3
GH 3,5mm	30°		43.062/3	43.062/3
GH 4,5mm	30°		43.062/4	43.062/4

4.8
MULTI-UNIT PLATFORM





TI-BASE

			RB/WB	WB
			3.5	4.5
	GH 0,8mm			15.063
	GH 1,5mm		 15.462	15.063/2
	GH 0,8mm			16.063
	GH 1,5mm		 16.462	16.063/2
ON SRA	4,6 Ø			15.098
				16.098



TI-BASE CASTABLES

				32.001-P5
				33.001-P5
ON SRA				32.098-P5
				33.098-P5

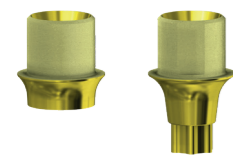

ANGLEBase®

	GH 1,5mm		36.062	36.063
	GH 1,5mm		37.062	37.063

PLASTIC SLEEVES FOR ANGLEBase®

	5 Pack.	0°	33.100-P5	33.100-P5
	5 Pack.	10°	33.101-P5	33.101-P5
	5 Pack.	20°	33.102-P5	33.102-P5



Torx Screw ANGLEBase®

(replacement screw)

Recommended torque

35 Ncm

	RB/WB	WB
	3.5	4.5
	19.441	19.441
	35 Ncm	35 Ncm



Torx BALL SCREWDRIVER

	20mm	24mm	30mm	35mm
	DT20TB06	DT24TB06	DT30TB06	DT35TB06



SCREW Torx

Recommended torque

19.054 19.054

35 Ncm 35 Ncm



On abutment SRA

4,6 Ø

10 Pack.

19.098

19.098-P10

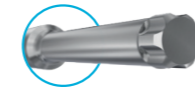

Recommended torque

15 Ncm

PRE-MILLED BLANK

Ø 10mm	Ti	61.062	
Ø 14mm	Ti		62.063
Ø 14mm	CoCr		71.063





NEO GM

compatible with
Neodent® Grand Morse

○ non-engaging

⬡ engaging



SCAN ABUTMENTS

GM

52.035



EXTISA extender for 52.xxx.



52.xxx includes manual tool DTPEIPEEK.



TRANSFER

17.035

Transfers include two screws (for open and closed tray).



DIGITAL ANALOGUE

Retention screw Hex 1,27 mm 19.712-P5

14.035/D



Platform Colour Coded



ANALOGUE

14.035



Platform Colour Coded



NEW
MUA+

GM

GH 0,8mm	0°	○	42.435/1
GH 1,5mm	0°	○	42.435/2
GH 2,5mm	0°	○	42.435/3
GH 3,5mm	0°	○	42.435/4
GH 1,5mm	17°	⬡	46.435/2
GH 2,5mm	17°	⬡	46.435/3
GH 1,5mm	30°	⬡	47.435/3
GH 2,5mm	30°	⬡	47.435/4



GH

GH



MULTI-UNIT ABUTMENTS

GH 1,5mm	0°	○	40.035/1
GH 2,5mm	0°	○	40.035/2
GH 3,5mm	0°	○	40.035/3
GH 2,5mm	17°	⬡	41.735/2
GH 3,5mm	17°	⬡	41.735/3
GH 3,5mm	30°	⬡	43.035/3
GH 4,5mm	30°	⬡	43.035/4



GH

NEW
TI-BASE



GH 1,5mm	○	15.455
GH 1,5mm	⬡	16.455

GM

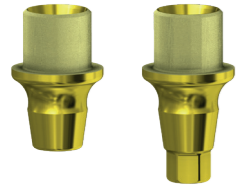

ANGLEBase®

GH 2,5mm	○	36.035/3
GH 2,5mm	◻	37.035/3

PLASTIC SLEEVES FOR ANGLEBase®

	5 Pack.	0°	33.100-P5
	5 Pack.	10°	33.101-P5
	5 Pack.	20°	33.102-P5

Torx® Screw ANGLEBase®



(replacement screw)	19.444
Recommended torque	20 Ncm

Torx® BALL SCREWDRIVER



	20mm	24mm	30mm	35mm
	DT20TB06	DT24TB06	DT30TB06	DT35TB06

SCREW NEO

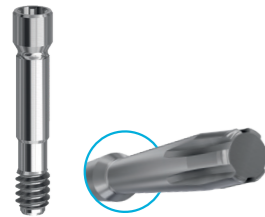

	19.051
Recommended torque	20 Ncm

PRE-MILLED BLANK



Ø 10mm	Ti	61.035
Ø 14mm	Ti	62.035
Ø 14mm	CoCr	71.035

NEW ASC BLANK



Ø 10mm	Ti	61.340
Ø 14mm	Ti	62.035

DESS® DESIGN:

FLAT SEAT ADVANTAGES



- Allows higher preload/clamping force between the structure and MUA.
- Less inaccuracies in internal milling of screw seat.
- DLC coating to minimize friction and enhance the preload/clampingforce even more.
- Length of screw allows more structure material under the screw-seat to strengthen both zirconia and temporary structures.
- Flat seat is self-centering and allows for a better alignment between diverging long-axis of the structure and MUA
- Torx connection compatible with DESS® Torx® ball screwdriver for angled screw channels.



Consequences of the inaccuracy of milling a cone in a Zr Superstructure

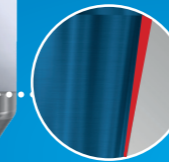

Contact point on the underside of the conical surface of the screw

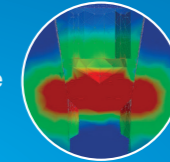

Contact point at the top of the conical surface of the screw

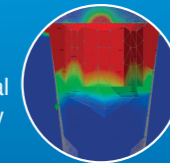

CONICAL SCREW SURFACE SEAT

REAL SURFACE CONTACT

- A conical head seating causes a reduction of the preload between the zirconia and the Multi-Unit.
- Screw sticks into the hole of the structure.
- Wrongly seating between between superstructure and conical shape of the screw.
- It is not possible to absorb the divergencies between the axis of the Multi-Unit and the hole of the superstructure milled.

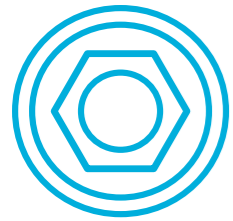

INTERNAL HEX USA

compatible with
Zimmer Screw-Vent®

○ non-engaging
⬡ engaging



HEALING ABUTMENT

	NP	RP	WP
	3.5	4.5	5.7
GH 3,0mm	20.017/3	20.018/3	20.019/3
GH 4,0mm	20.017/4	20.018/4	20.019/4
GH 5,0mm	20.017/5	20.018/5	20.019/5



SCAN ABUTMENTS

52.017 52.018 52.019



EXTISA extender for 52.xxx.



52.xxx includes manual tool DTPEIPEEK.



TRANSFER

17.017 17.018 17.019

Transfers include two screws (for open and closed tray).



Platform Colour Coded

DIGITAL ANALOGUE

Retention screw Hex 1,27 mm 19.712-P5

14.017/D 14.018/D 14.019/D



Platform Colour Coded

ANALOGUE

10 Pack.

14.017 14.018 14.019
14.017-P10 14.018-P10



TEMPORARY ABUTMENT

	NP	RP	WP
	3.5	4.5	5.7
○	24.017	24.018	24.019
⬡	25.017	25.018	25.019



DESSLoc®

GH 1,0mm	88.017/1	88.018/1	88.019/1
GH 2,5mm	88.017/2	88.018/2	88.019/2
GH 3,5mm	88.017/3	88.018/3	88.019/3
GH 4,5mm	88.017/4	88.018/4	88.019/4
GH 5,5mm	88.017/5	88.018/5	88.019/5
GH 6,5mm	88.017/6 <small>FDA & Canada only</small>	88.018/6 <small>FDA & Canada only</small>	88.019/6 <small>FDA & Canada only</small>



MULTI-UNIT ABUTMENTS

GH 1,0mm	0°	○	40.019/1	40.020/1
GH 2,0mm	0°	○	40.019/2	40.020/2
GH 3,0mm	0°	○	40.019/3	40.020/3
GH 4,0mm	0°	○	40.019/4	40.020/4
GH 5,0mm	0°	○	40.019/5	40.020/5
GH 2,5mm	17°	⬡	41.719/2	41.720/2
GH 3,5mm	17°	⬡	41.719/3	41.720/3
GH 3,5mm	30°	⬡	43.019/3	43.020/3
GH 4,5mm	30°	⬡	43.019/4	43.020/4

4.8
MULTI-UNIT PLATFORM



TI-BASE			NP	RP	WP
			3.5	4.5	5.7
GH 0,3mm	◯			15.018	15.019
GH 1,5mm	◯		15.430	15.218	15.219
GH 3,0mm	◯			15.318	15.319
GH 0,3mm	◻			16.018	16.019
GH 1,5mm	◻		16.430	16.218	16.219
GH 3,0mm	◻			16.318	16.319



TI-BASE CASTABLES					
5 Pack.	◯			32.001-P5	32.001-P5
5 Pack.	◻			33.001-P5	33.001-P5

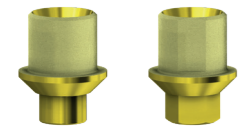

ANGLEBase®					
	◯		36.017	36.018	36.019
	◻		37.017	37.018	37.019



PLASTIC SLEEVES FOR ANGLEBase®					
5 Pack.	0°		33.100-P5	33.100-P5	33.100-P5
5 Pack.	10°		33.101-P5	33.101-P5	33.101-P5
5 Pack.	20°		33.102-P5	33.102-P5	33.102-P5

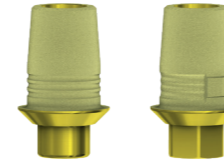

C-Base®			NP	RP	WP
			3.5	4.5	5.7
GH 0,5mm	◯		58.017	58.018	58.019
GH 1,5mm	◯		58.017/2	58.018/2	58.019/2
GH 3,0mm	◯		58.017/3	58.018/3	58.019/3
GH 0,5mm	◻		59.017	59.018	59.019
GH 1,5mm	◻		59.017/2	59.018/2	59.019/2
GH 3,0mm	◻		59.017/3	59.018/3	59.019/3

Includes screw, same as standard screw.

Libraries available for EXOCAD & 3Shape.

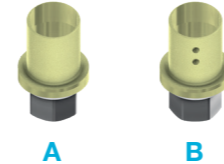

ELLIPTIBase®					
A corner	◊			56.017	
B flat	◻			57.017	



Torx® Screw ANGLEBase® & ELLIPTIBase®					
(replacement screw)			19.417	19.417	19.417
Recommended torque			30 Ncm	30 Ncm	30 Ncm



Torx® BALL SCREWDRIVER	20mm	24mm	30mm	35mm
	DT20TB06	DT24TB06	DT30TB06	DT35TB06



ABUTMENTS					
	0°		13.017	13.018	13.019

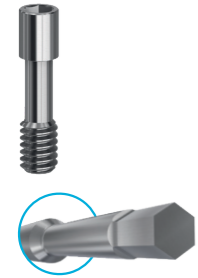

SCREW HEX 1,27mm

	NP	RP	WP
	3.5	4.5	5.7
	19.042	19.042	19.042
10 Pack.	19.042-P10	19.042-P10	19.042-P10
Recommended torque	30 Ncm	30 Ncm	30 Ncm



PRE-MILLED BLANK

Ø 10mm	Ti	61.017	61.018	61.019
Ø 14mm	Ti	62.017	62.018	62.019
Ø 14mm	CoCr	71.017	71.018	71.019



CoCr BASE

	◯	30.017	30.018	30.019
	◡	31.017	31.018	31.019



CASTABLE

	◯	28.017 19.012	28.018 19.012	28.019 19.012
10 Pack.			11.018-P10	
	◡	29.017 19.012	29.018 19.012	29.019 19.012
10 Pack.		12.017-P10	12.018-P10	

ANGLEBase®

ANGLEBase® is our solution to clinical situations where the the implant's long-axis results in an unfavorable location of the prosthetic screw access hole.



1. 25° Maximum angulation.
2. 360° freedom.
3. SelectGrip®
4. Titanium Grade V.

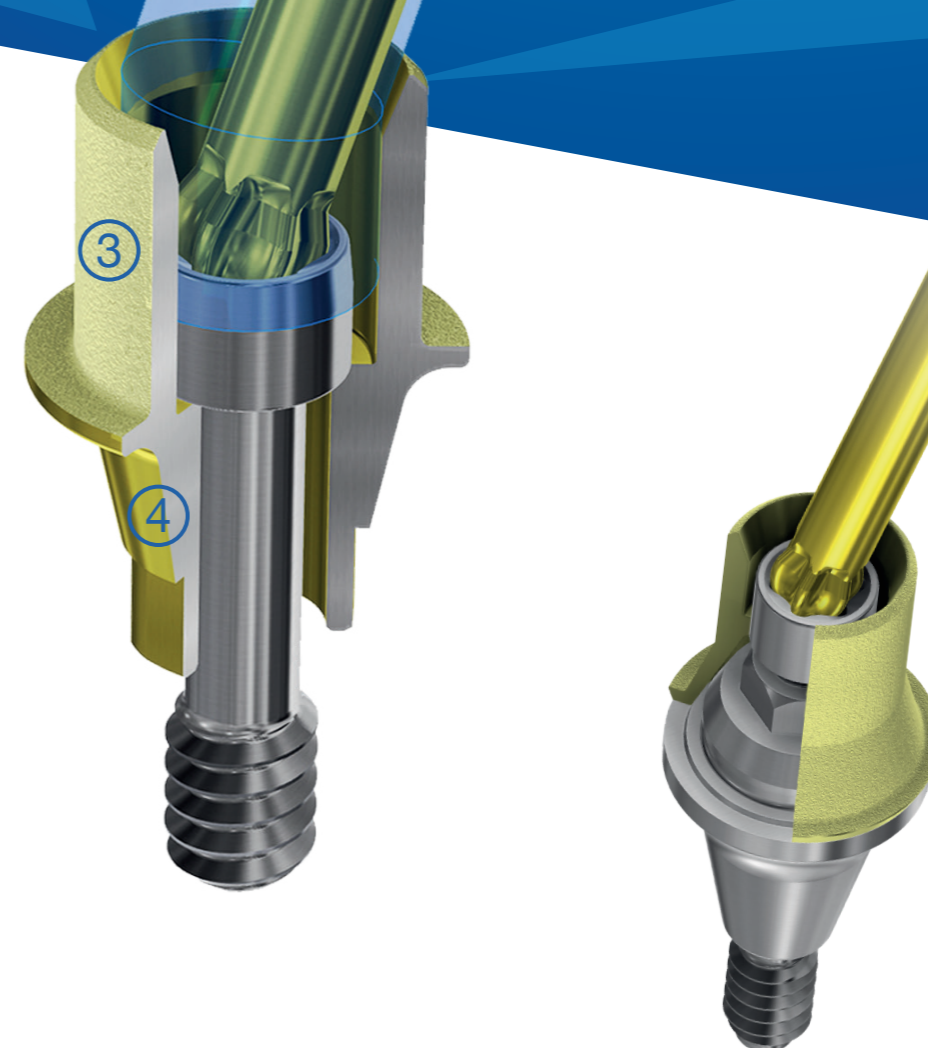

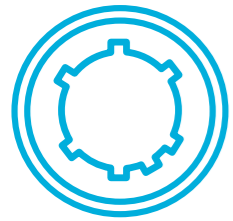

CONIC EVO

compatible with
Astra Tech implant system™ EV

-  non-engaging
-  engaging



HEALING ABUTMENT

	EV/3.0	EV/3.6	EV/4.2	EV/4.8	EV/5.4
	3.0	3.6	4.2	4.8	5.4
GH 3,5mm	20.406/3	20.059/3	20.060/3	20.061/3	20.407/3
GH 4,5mm	20.406/4	20.059/4	20.060/4	20.061/4	20.407/4
GH 6,5mm	20.406/6	20.059/6	20.060/6	20.061/6	20.407/6



SCAN ABUTMENTS

	EV/3.0	EV/3.6	EV/4.2	EV/4.8	EV/5.4
	52.406	52.059	52.060	52.061	52.407
On uniabutment®	52.058				



EXTISA extender for 52.xxx.



52.xxx includes manual tool DTPEIPEEK.



TRANSFER

	EV/3.0	EV/3.6	EV/4.2	EV/4.8	EV/5.4
	17.406	17.059	17.060	17.061	17.407
On uniabutment®	17.058				

Transfers include two screws (for open and closed tray).



Platform Colour Coded

DIGITAL ANALOGUE

	EV/3.0	EV/3.6	EV/4.2	EV/4.8	EV/5.4
	3.0	3.6	4.2	4.8	5.4
Retention screw Hex 1,27 mm 19.712-P5	14.406/D	14.059/D	14.060/D	14.061/D	14.407/D
On uniabutment®	14.058/D				



Platform Colour Coded

ANALOGUE

	EV/3.0	EV/3.6	EV/4.2	EV/4.8	EV/5.4
	14.406	14.059	14.060	14.061	14.407
On uniabutment®	14.058				



TEMPORARY ABUTMENT

	EV/3.0	EV/3.6	EV/4.2	EV/4.8	EV/5.4
	24.406	24.059	24.060	24.061	24.407
	25.406	25.059	25.060	25.061	25.407
On uniabutment®	24.058				



DESSLoc®

GH 1,0mm	88.059/1	88.060/1	88.061/1
GH 2,0mm	88.059/2	88.060/2	88.061/2
GH 3,0mm	88.059/3	88.060/3	88.061/3
GH 4,0mm	88.059/4	88.060/4	88.061/4



UNIABUTMENT®

	EV/3.0	EV/3.6	EV/4.2	EV/4.8	EV/5.4
	3.0	3.6	4.2	4.8	5.4

GH 1,0mm		40.059/1	40.060/1	40.061/1	
GH 2,0mm		40.059/2	40.060/2	40.061/2	
GH 3,0mm		40.059/3	40.060/3	40.061/3	
GH 5,0mm		40.059/5	40.060/5	40.061/5	

UniAbutment® needs a 1,75mm hex screwdriver



MULTI-UNIT ABUTMENTS

GH 1,5mm	0°	○	40.406/1	40.027/1	40.036/1	40.037/1	40.407/1
GH 2,5mm	0°	○	40.406/2	40.027/2	40.036/2	40.037/2	40.407/2
GH 3,5mm	0°	○	40.406/3	40.027/3	40.036/3	40.037/3	40.407/3
GH 3,5mm	17°	⊗		41.727/3	41.736/3	41.737/3	
GH 4,5mm	17°	⊗		41.727/4	41.736/4	41.737/4	
GH 4,5mm	30°	⊗		43.027/4	43.036/4	43.037/4	
GH 5,5mm	30°	⊗		43.027/5	43.036/5	43.037/5	

4.8
MULTI-UNIT PLATFORM



TI-BASE

GH 1,0mm	○		15.059	15.060	15.061	15.407
GH 1,5mm	○	NEW 15.406				
GH 3,0mm	○		15.359	15.360	15.361	
GH 1,0mm	⊗		16.059	16.060	16.061	16.407
GH 1,5mm	⊗	NEW 16.406				
GH 3,0mm	⊗		16.359	16.360	16.361	
On uniabutment®	○		15.058			



TI-BASE CASTABLES

5 Pack.	○	32.001-P5	32.001-P5	32.001-P5	32.001-P5
5 Pack.	⊗	33.001-P5	33.001-P5	33.001-P5	33.001-P5
5 Pack.	○	32.001-P5			

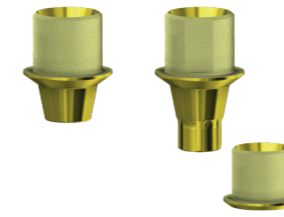

ANGLEBase®

	EV/3.0	EV/3.6	EV/4.2	EV/4.8	EV/5.4
	3.0	3.6	4.2	4.8	5.4

	○		36.059	36.060	36.061
	⊗		37.059	37.060	37.061
On uniabutment®	○		36.058		

PLASTIC SLEEVES FOR ANGLEBase®

5 Pack.	0°		33.100-P5	33.100-P5	33.100-P5
5 Pack.	10°		33.101-P5	33.101-P5	33.101-P5
5 Pack.	20°		33.102-P5	33.102-P5	33.102-P5

On Uniabutment®

5 Pack.	0°	33.100-P5
5 Pack.	10°	33.101-P5
5 Pack.	20°	33.102-P5

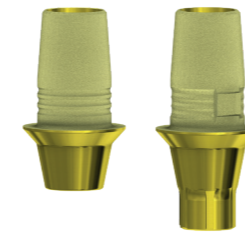

C-Base®

GH 1,0mm	○	58.059	58.060	58.061
GH 3,0mm	○	58.059/3	58.060/3	58.061/3
GH 1,0mm	⊗	59.059	59.060	59.061
GH 3,0mm	⊗	59.059/3	59.060/3	59.061/3

Includes screw, same as standard screw.

Libraries available for EXOCAD & 3Shape.

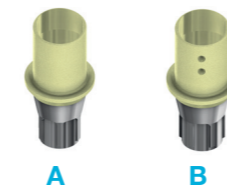

ELLIPTIBase®

A corner	⬠	56.406
B flat	⬡	57.406

Torx® Screw ANGLEBase® & ELLIPTIBase®

(replacement screw)	19.468	19.441	19.460	19.461
Recommended torque	15 Ncm	25 Ncm	25 Ncm	25 Ncm



Torx® BALL SCREWDRIVER

	20mm	24mm	30mm	35mm
	DT20TB06	DT24TB06	DT30TB06	DT35TB06





SCREW HEX 1,27mm

	EV/3.0	EV/3.6	EV/4.2	EV/4.8	EV/5.4
	3.0	3.6	4.2	4.8	5.4
	19.071	19.059	19.060	19.061	19.061
<i>Recommended torque</i>	25 Ncm	25 Ncm	25 Ncm	25 Ncm	25 Ncm

On uniabutment® 19.058

Recommended torque 15 Ncm



PRE-MILLED BLANK

Ø	Material	EV/3.0	EV/3.6	EV/4.2	EV/4.8	EV/5.4
Ø 10mm	Ti	61.406	61.059	61.060	61.061	61.407
Ø 14mm	Ti		62.059	62.060	62.061	62.407
Ø 14mm	CoCr		71.059	71.060	71.061	71.407

CoCr BASE



	○	30.059	30.060	30.061
	⊗	31.059	31.060	31.061
On uniabutment®	○	30.058		

CASTABLE



	○	28.059	28.060	28.061
On uniabutment®	○	28.058		



More secure and stable prosthesis. Same top part as the Nobel® System, independently of the chosen system

Vertical screw access facilitates placement and improve the stability of the Multi-Unit abutment

Smooth gingival transition thanks to its anatomical shape that favors rapid adaptation of the gingiva to the abutment.

periocoat®

- Less inflammation.
- Less plaque adhesion.
- Higher corrosion resistance.
- Easier to clean.
- 6x harder than Titanium Oxide.

Full shaped connection provides more stability.

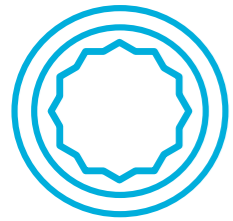

INTERNAL HEX CONIC

compatible with
Astra Tech Osseospeed™

○ non-engaging

○ engaging



HEALING ABUTMENT

		NP	RP	WP
		3.0	3.5-4.0	4.5-5.0
	GH 3,0mm		20.024/3	20.025/3
	GH 4,0mm		20.024/4	20.025/4
	GH 5,0mm		20.024/5	20.025/5
Anatomic	GH 4,0mm	Ø 4,5	20.424/4	
	GH 4,0mm	Ø 5,5	20.524/4	20.525/4
	GH 4,0mm	Ø 6,5		20.625/4



SCAN ABUTMENTS

			NP	RP	WP
			52.023	52.024	52.025
On uniabutment®	20°	52.036			
	45°	52.037			



EXTISA extender for 52.xxx.



52.xxx includes manual tool DTPEIPEEK.



TRANSFER

			NP	RP	WP
			17.023	17.024	17.025
On uniabutment®	20°	17.036			
	45°	17.037			

Transfers include two screws (for open and closed tray).

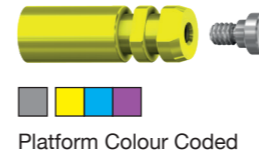

Platform Colour Coded

DIGITAL ANALOGUE

			NP	RP	WP
			3.0	3.5-4.0	4.5-5.0
Retention screw Hex 1,27 mm 19.712-P5			14.023/D	14.024/D	14.025/D
Of uniabutment®	20°	14.036/D			
	45°	14.037/D			

*Other retention screws available, see page 126

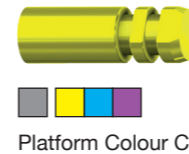

Platform Colour Coded

ANALOGUE

			NP	RP	WP
			14.023	14.024	14.025
	10 Pack.			14.024-P10	14.025-P10
Of uniabutment®	20°	14.036			
	45°	14.037			



TEMPORARY ABUTMENT

			NP	RP	WP
			24.023	24.024	24.025
On uniabutment®	20°	○	24.023	24.024	24.025
	45°	○	25.023	25.024	25.025
		○	24.028		
		○	24.029		



DESSLoc®

	NP	RP	WP
	3.0	3.5-4.0	4.5-5.0
GH 1,0mm	88.023/1	88.024/1	88.025/1
GH 2,0mm	88.023/2	88.024/2	88.025/2
GH 3,0mm	88.023/3	88.024/3	88.025/3
GH 4,0mm	88.023/4	88.024/4	88.025/4

UNIABUTMENT®

GH 0,5mm	20°	40.013/0	40.015/0
GH 1,0mm	20°	40.013/1	40.015/1
GH 2,0mm	20°	40.013/2	40.015/2
GH 4,0mm	20°	40.013/4	40.015/4
GH 6,0mm	20°	40.013/6	40.015/6
GH 0,5mm	45°	40.014/0	40.016/0
GH 1,0mm	45°	40.014/1	40.016/1
GH 2,0mm	45°	40.014/2	40.016/2
GH 4,0mm	45°	40.014/4	40.016/4
GH 6,0mm	45°	40.014/6	40.016/6

MULTI-UNIT ABUTMENTS

GH 1,5mm	0°	○	40.024/1	40.025/1
GH 2,5mm	0°	○	40.024/2	40.025/2
GH 3,5mm	0°	○	40.024/3	40.025/3
GH 3,5mm	17°	○	41.724/3	41.725/3
GH 4,5mm	17°	○	41.724/4	41.725/4
GH 4,5mm	30°	○	43.024/4	43.025/4
GH 5,5mm	30°	○	43.024/5	43.025/5

4.8
MULTI-UNIT PLATFORM

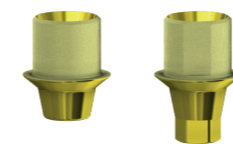

TI-BASE

	NP	RP	WP
	3.0	3.5-4.0	4.5-5.0
GH 0,9mm	○		15.025
GH 1,1mm	○	15.024	
GH 1,5mm	○	15.423	
GH 2,0mm	○	15.024/2	15.025/2
GH 3,0mm	○	15.324	15.325
GH 0,9mm	○		16.025
GH 1,1mm	○	16.024	
GH 1,5mm	○	16.423	
GH 2,0mm	○	16.024/2	16.025/2
GH 3,0mm	○	16.324	16.325
On uniabutment®	20°	○	15.036
	45°	○	15.037

TI-BASE CASTABLES



5 Pack.	○	32.001-P5	32.001-P5
5 Pack.	○	33.001-P5	33.001-P5

On uniabutment® 32.001-P5

ANGLEBase®

	○	36.024	36.025
	○	37.024	37.025

PLASTIC SLEEVES FOR ANGLEBase®



5 Pack.	0°	33.100-P5	33.100-P5
5 Pack.	10°	33.101-P5	33.101-P5
5 Pack.	20°	33.102-P5	33.102-P5

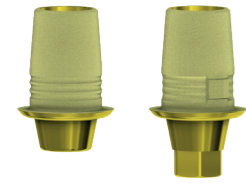

C-Base®

		NP 3.0	RP 3.5-4.0	WP 4.5-5.0
GH 0,8mm	○		58.024	
GH 0,9mm	○			58.025
GH 3,0mm	○		58.024/3	58.025/3
GH 0,8mm	○		59.024	
GH 0,9mm	○			59.025
GH 3,0mm	○		59.024/3	59.025/3

Includes screw, same as standard screw.

Libraries available for EXOCAD & 3Shape.

Torx® Screw ANGLEBase®



(replacement screw)

Recommended torque

Torx® BALL SCREWDRIVER



	20mm	24mm	30mm	35mm
	DT20TB06	DT24TB06	DT30TB06	DT35TB06

ABUTMENTS



0°		13.024	13.025
----	--	--------	--------



SCREW HEX 1,27mm

	NP 3.0	RP 3.5-4.0	WP 4.5-5.0
	19.015	19.016	19.017
Recommended torque	15 Ncm	20 Ncm	25 Ncm
On uniabutment®		19.018	
10 Pack.		19.018-P10	
Recommended torque		15 Ncm	

PRE-MILLED BLANK



Ø 10mm	Ti	61.023	61.024	61.025
Ø 14mm	Ti		62.024	62.025
Ø 14mm	CoCr		71.024	

CoCr BASE



		○		30.024	30.025
		○		31.024	31.025
On uniabutment®	20°	○	30.036		
	45°	○	30.037		

CASTABLE



		○		28.024	28.025
		○		29.024	29.025
On uniabutment®	20°	○	28.036		
On uniabutment®	45°	○	28.037		

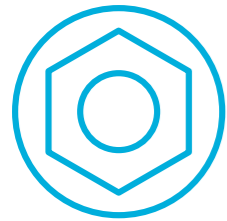

INTERNAL HEX FD

compatible with
Xive®

The INTERNAL HEX FD connection will be available while stocks last.

-  non-engaging
-  engaging





HEALING ABUTMENT

	NP	RP	WP	5.5
	3.4	3.8	4.5	5.5
GH 3,0mm	20.036/3	20.037/3	20.038/3	
GH 4,0mm	20.036/4	20.037/4	20.038/4	
GH 5,0mm	20.036/5	20.037/5	20.038/5	



SCAN ABUTMENTS

		52.038	52.039	52.040	52.071
 EXTISA extender for 52.xxx.					
 52.xxx includes manual tool DTPEIPEEK.					



TRANSFER

	17.038	17.039	17.040	17.071

Transfers include two screws (for open and closed tray).

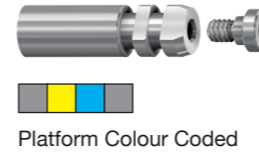

DIGITAL ANALOGUE

Retention screw Hex 1,27 mm 19.712-P5



Platform Colour Coded

	NP	RP	WP	5.5
	3.4	3.8	4.5	5.5
	14.038/D	14.039/D	14.040/D	14.071/D



ANALOGUE



Platform Colour Coded

	14.038	14.039	14.040	14.071
10 Pack.		14.039-P10		



TEMPORARY ABUTMENT

		24.038	24.039	24.040
		25.038	25.039	25.040



DESSLoc®

GH 1,0mm	88.036/1	88.037/1
GH 2,0mm	88.036/2	88.037/2
GH 3,0mm	88.036/3	88.037/3
GH 4,0mm	88.036/4	88.037/4



TI-BASE		NP	RP	WP	5.5	
		3.4	3.8	4.5	5.5	
	GH 0,3mm	○	15.038	15.039	15.040	15.071
	GH 1,5mm	○	15.238	15.239	15.240	15.271
	GH 3,0mm	○	15.338	15.339	15.340	15.371
	GH 0,3mm	⬡	16.038	16.039	16.040	16.071
	GH 1,5mm	⬡	16.238	16.239	16.240	16.271
	GH 3,0mm	⬡	16.338	16.339	16.340	16.371



TI-BASE CASTABLES

5 Pack.	○	32.001-P5	32.001-P5	32.001-P5	32.001-P5
5 Pack.	⬡	33.001-P5	33.001-P5	33.001-P5	33.001-P5

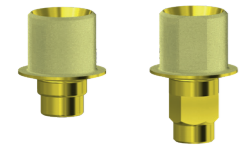

ANGLEBase®					
		○	36.038	36.039	36.040
		⬡	37.038	37.039	37.040

PLASTIC SLEEVES FOR ANGLEBase®

5 Pack.	0°	33.100-P5	33.100-P5	33.100-P5
5 Pack.	10°	33.100-P5	33.101-P5	33.101-P5
5 Pack.	20°	33.100-P5	33.102-P5	33.102-P5

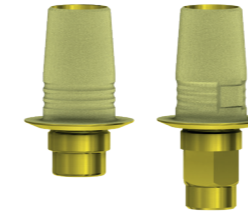

C-Base®		NP	RP	WP	5.5
		3.4	3.8	4.5	5.5
	GH 0,3mm	○	58.038	58.039	
	GH 0,6mm	○			58.040 58.071
	GH 1,5mm	○	58.038/2	58.039/2	58.040/2 58.071/2
	GH 3,0mm	○	58.038/3	58.039/3	58.040/3 58.071/3
	GH 0,3mm	⬡	59.038	59.039	
	GH 0,6mm	⬡			59.040 59.071
	GH 1,5mm	⬡	59.038/2	59.039/2	59.040/2 59.071/2
	GH 3,0mm	⬡	59.038/3	59.039/3	59.040/3 59.071/3

Includes screw, same as standard screw.

Libraries available for EXOCAD & 3Shape.



Torx® Screw ANGLEBase®

(replacement screw)	19.438	19.438	19.438
Recommended torque	24 Ncm	24 Ncm	24 Ncm



Torx® BALL SCREWDRIVER

	20mm	24mm	30mm	35mm
	DT20TB06	DT24TB06	DT30TB06	DT35TB06



ABUTMENTS

0°	13.038	13.039	13.040
----	--------	--------	--------

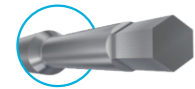

SCREW HEX 1,22mm

	19.024	19.024	19.024	19.024
<i>Recommended torque</i>	<i>24 Ncm</i>	<i>24 Ncm</i>	<i>24 Ncm</i>	<i>24 Ncm</i>



PRE-MILLED BLANK

Ø 10mm	Ti	61.038	61.039	61.040	61.071
Ø 14mm	Ti		62.039	62.040	62.071
Ø 14mm	CoCr	71.038	71.039		71.071



CoCr BASE

	30.038	30.039	30.040
	31.038	31.039	31.040

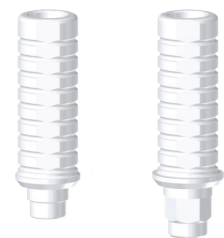

CASTABLE

	28.038	28.039	28.040
	29.038	29.039	29.040

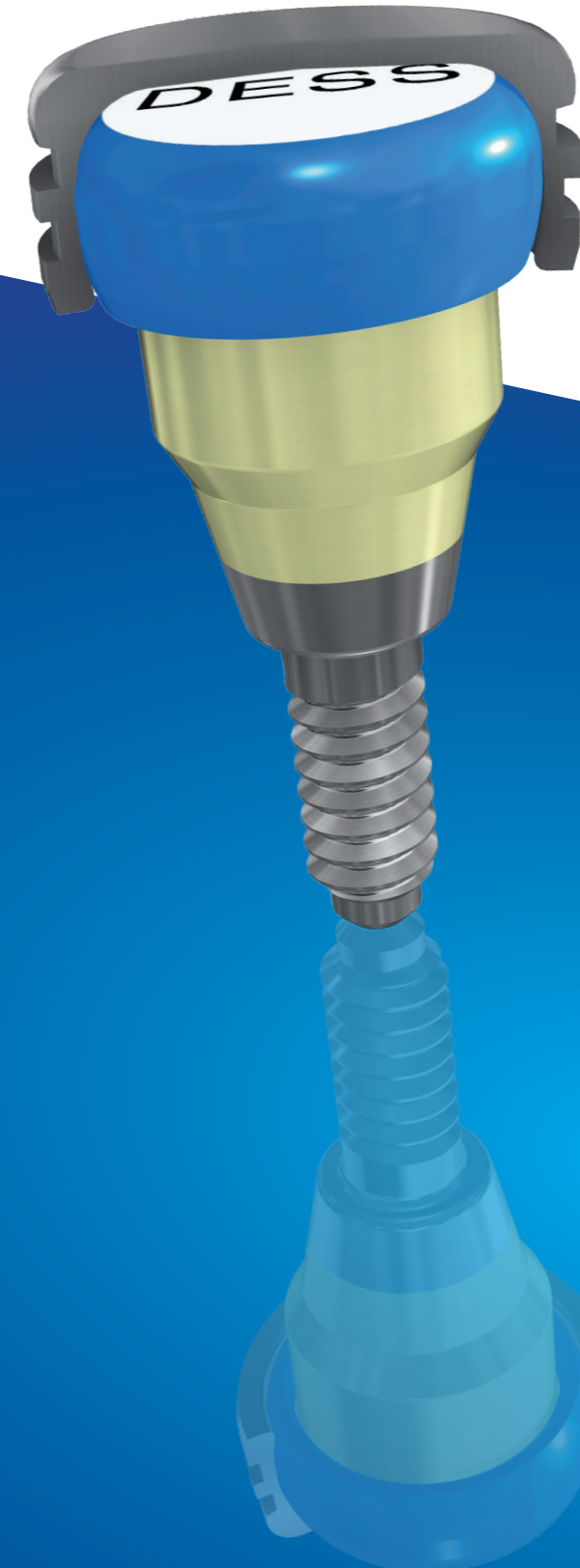

DESSLoc®

Superior resistance, better clinical results

DESS® overdenture system has a Zirconium Nitride coating, which offers improved strength with less plaque adhesion, improving clinical outcomes and reducing gingival inflammation.

- 100% compatible with the most widely used system.
- Reduces plaque adhesion.
- Reduces gingival inflammation.



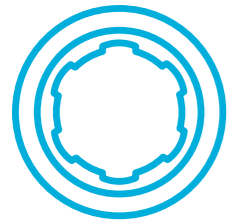

INTERNAL ANK

○ non-engaging
 ⬡ engaging

compatible with
 Dentsply Ankylos® C/X



HEALING ABUTMENT

GH 1,5mm	20.046/1
GH 2,5mm	20.046/3



SCAN ABUTMENTS

52.049



EXTISA extender for 52.xxx.



52.xxx includes manual tool DTPEIPEEK.



TRANSFER

GH 1,5mm	17.049
GH 2,5mm	17.250

Transfers include two screws (for open and closed tray).



Platform Colour Coded

DIGITAL ANALOGUE

Ø 3,5	14.048/D
Ø 4,5	14.049/D

Retention screw Hex 1,27 mm 19.712-P5



Platform Colour Coded

ANALOGUE

Ø 3,5	14.048
10 Pack.	14.048-P10
Ø 4,5	14.049
10 Pack.	14.049-P10



TEMPORARY ABUTMENT

GH 1,5mm	○	24.048
GH 2,5mm	○	24.250
GH 1,5mm	⬡	25.048
GH 2,5mm	⬡	25.250







DESSLoc®

GH 2,0mm	88.046/2
GH 3,0mm	88.046/3
GH 4,0mm	88.046/4



TI-BASE

GH 1,5mm		15.050
GH 2,5mm		15.250
GH 1,5mm		16.050
GH 2,5mm		16.250







TI-BASE CASTABLES

5 Pack.		32.001-P5
5 Pack.		33.001-P5



C-Base®

GH 1,4mm		58.050
GH 2,5mm		58.050/2
GH 1,4mm		59.050
GH 2,5mm		59.050/2

Includes screw, same as standard screw.

Libraries available for EXOCAD & 3Shape.

Replacement Screw for C-Base®



Recommended torque

19.702

15 Ncm



ABUTMENTS

GH 1,5mm	0°	13.047
GH 2,5mm	0°	13.250



SCREW HEX 1,00mm

GH 1,5mm	19.048
GH 2,5mm	19.050

Recommended torque

15 Ncm



PRE-MILLED BLANK

Ø 10mm	Ti	61.250
--------	----	--------



CoCr BASE

GH 1,5mm		30.050
GH 2,5mm		30.250
GH 1,5mm		31.050
GH 2,5mm		31.250



CASTABLE

GH 1,5mm		28.048
GH 2,5mm		28.250

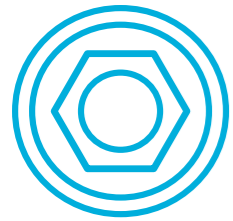

CONIC OSS

compatible with
Osstem® TS / HIOSSEN® ET

- non-engaging
- engaging



SCAN ABUTMENTS

	Mini	STD
	Mini	Regular
	52.072	52.073



EXTISA extender for 52.xxx.



52.xxx includes manual tool DTPEIPEEK.



TRANSFER

	17.072	17.073
--	--------	--------

Transfers include two screws (for open and closed tray).



DIGITAL ANALOGUE

Retention screw Hex 1,27 mm 19.712-P5

	14.072/D	14.073/D
--	----------	----------



Platform Colour Coded



ANALOGUE

	14.072	14.073
--	--------	--------



Platform Colour Coded



TEMPORARY ABUTMENT

-
-

	Mini	STD
	Mini	Regular
	24.072	24.073
	25.072	25.073



MULTI-UNIT ABUTMENTS

GH 1,5mm	0°	<input type="radio"/>
GH 2,5mm	0°	<input type="radio"/>
GH 3,5mm	0°	<input type="radio"/>

	40.072/1	40.073/1
	40.072/2	40.073/2
	40.072/3	40.073/3

4.8
MULTI-UNIT PLATFORM



TI-BASE

GH 1,0mm	<input type="radio"/>
GH 3,0mm	<input type="radio"/>
GH 1,0mm	<input type="radio"/>
GH 3,0mm	<input type="radio"/>

	15.072	15.073
	15.372	15.373
	16.072	16.073
	16.372	16.373



TI-BASE CASTABLES

5 Pack.	<input type="radio"/>
5 Pack.	<input type="radio"/>

	32.001-P5	32.001-P5
	33.001-P5	33.001-P5

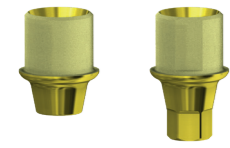

ANGLEBase®

		Mini	STD
		Mini	Regular
		36.072	36.073
		37.072	37.073
PLASTIC SLEEVES FOR ANGLEBase®			
	5 Pack.	0°	33.100-P5 33.100-P5
	5 Pack.	10°	33.101-P5 33.101-P5
	5 Pack.	20°	33.102-P5 33.102-P5

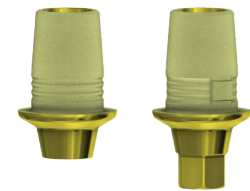

C-Base®

GH 1,0mm		58.072	58.073
GH 1,0mm		59.072	59.073
GH 3,0mm		59.072/3	59.073/3

Includes screw, same as standard screw.

Libraries available for EXOCAD & 3Shape.



Torx® Screw ANGLEBase®

(replacement screw)	19.444	19.461
Recommended torque	20 Ncm	30 Ncm



Torx® BALL SCREWDRIVER	20mm	24mm	30mm	35mm
	DT20TB06	DT24TB06	DT30TB06	DT35TB06

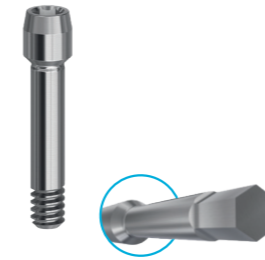

SCREW HEX 1,22mm

	Mini	STD
	Mini	Regular
	19.072	19.073
Recommended torque	20 Ncm	30 Ncm



PRE-MILLED BLANK

Ø 10mm	Ti	61.072	61.073
Ø 14mm	Ti	62.072	62.073
Ø 14mm	CoCr	71.072	



CoCr BASE

	30.072	30.073
	31.072	31.073

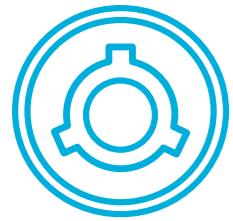

INTERNAL CAM

compatible with
Camlog®

-  non-engaging
-  engaging





HEALING ABUTMENT

	3.3	3.8	4.3	5.0
GH 3,0mm	20.065/3	20.066/3		
GH 4,0mm	20.065/4	20.066/4		
GH 5,0mm	20.065/5	20.066/5		



SCAN ABUTMENTS

	52.064	52.065	52.066	52.067
 EXTISA extender for 52.xxx.				
 52.xxx includes manual tool DTPEIPEEK.				



TRANSFER

	17.064	17.065	17.066	17.067

Transfers include two screws (for open and closed tray).



Platform Colour Coded

DIGITAL ANALOGUE

Retention screw Hex 1,27 mm 19.712-P5

	3.3	3.8	4.3	5.0
	14.064/D	14.065/D	14.066/D	14.067/D





Platform Colour Coded

ANALOGUE

	14.064	14.065	14.066	14.067
--	--------	--------	--------	--------



TEMPORARY ABUTMENT









	24.065	24.066
	25.065	25.066





DESSLoc®

GH 1,0mm	88.065/1	88.066/1
GH 2,0mm	88.065/2	88.066/2
GH 3,0mm	88.065/3	88.066/3
GH 4,0mm	88.065/4	88.066/4





TI-BASE		3.3	3.8	4.3	5.0
		3.3	3.8	4.3	5.0
GH 0,3mm			15.065	15.066	15.067
GH 0,5mm		15.064			
GH 1,5mm			15.265	15.266	
GH 3,0mm			15.365	15.366	
GH 0,3mm			16.065	16.066	16.067
GH 0,5mm		16.064			
GH 1,5mm			16.265	16.266	
GH 3,0mm			16.365	16.366	

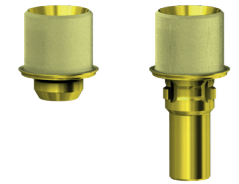

TI-BASE CASTABLES					
5 Pack.		32.001-P5	32.001-P5	32.001-P5	32.001-P5
5 Pack.		33.001-P5	33.001-P5	33.001-P5	33.001-P5



ANGLEBase®			
		36.065	36.066
		37.065	37.066



PLASTIC SLEEVES FOR ANGLEBase®			
5 Pack.	0°	33.100-P5	33.100-P5
5 Pack.	10°	33.101-P5	33.101-P5
5 Pack.	20°	33.102-P5	33.102-P5



Torx® Screw ANGLEBase®		
(replacement screw)		19.444
Recommended torque		20 Ncm



Torx® BALL SCREWDRIVER	20mm	24mm	30mm	35mm
	DT20TB06	DT24TB06	DT30TB06	DT35TB06



SCREW HEX 1,27mm	3.3	3.8	4.3	5.0
	3.3	3.8	4.3	5.0
	19.044	19.044	19.044	19.045
Recommended torque	20 Ncm	20 Ncm	20 Ncm	20 Ncm



PRE-MILLED BLANK					
Ø 10mm	Ti	61.064	61.065	61.066	61.067
Ø 14mm	Ti		62.065	62.066	62.067
Ø 14mm	CoCr	71.064		71.066	71.067



CoCr BASE			
		30.065	30.066
		31.065	31.066



CASTABLE		
		28.065
		28.066

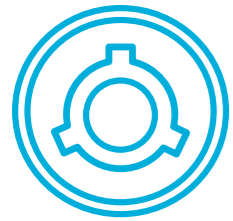

INTERNAL CON

compatible with
Conelog®

- non-engaging
- engaging



SCAN ABUTMENTS

	NP	RP	WP
	3.3	3.8/4.3	5.0
	52.074	52.075	52.076



EXTISA extender for 52.xxx.



52.xxx includes manual tool DTPEIPEEK.



TRANSFER

	17.074	17.075	17.076
--	--------	--------	--------

Transfers include two screws (for open and closed tray).



DIGITAL ANALOGUE

Retention screw Hex 1,27 mm 19.712-P5

	14.074/D	14.075/D	14.076/D
--	----------	----------	----------

Platform Colour Coded



ANALOGUE

	14.074	14.075	14.076
--	--------	--------	--------

Platform Colour Coded

periocoat®

ZrN

Enhanced Surface Treatment

- Less inflammation.
- Less plaque adhesion.
- Higher corrosion resistance.
- Easier to clean.
- 6x harder than Titanium Oxide.



Less biofilm genesis on the surface

With less biofilm and plaque, there will be less quantity and quality of bacteria that can cause soft tissue inflammation.



Increased collagen stability

ZrN creates less of an inflammatory burden and collagen degradation in the gingival tissue as evidenced by less aMMP8 biomarker in the gingival fluid.



Surface is more resistant to corrosion

Dental plaque produces acid that will corrode the surface and increase roughness. ZrN is harder and has a smaller friction coefficient, which makes it more resistant to corrosion.



Increased adhesion of fibroblasts

A higher adhesion of fibroblasts locks the path between the surface and soft tissue preventing bacteria to enter the gingival margin.



Six times harder than Titanium Oxide

Will not scratch as easily when cleaned using cures, ultrasound or other instruments.



ZrN has a warm gold hue

A warmer goldish hue has aesthetic advantages compared to the titanium grey.



INTERNAL HEX BH

compatible with
BioHorizons® internal

○ non-engaging
⬡ engaging



HEALING ABUTMENT

	3.0	NP	RP	WP
	3.0	3.5	4.5	5.7
GH 3,0mm		20.087/3	20.088/3	20.089/3
GH 4,0mm		20.087/4	20.088/4	20.089/4
GH 5,0mm		20.087/5	20.088/5	20.089/5



SCAN ABUTMENTS

	3.0	NP	RP	WP
	3.0	3.5	4.5	5.7
	52.099	52.087	52.088	52.089



EXTISA extender for 52.xxx.



52.xxx includes manual tool DTPEIPEEK.



TRANSFER

	3.0	NP	RP	WP
	3.0	3.5	4.5	5.7
		17.087	17.088	17.089

Transfers include two screws (for open and closed tray).



Platform Colour Coded

DIGITAL ANALOGUE

	3.0	NP	RP	WP
	3.0	3.5	4.5	5.7
Retention screw Hex 1,27 mm 19.712-P5	14.099/D	14.087/D	14.088/D	14.089/D



Platform Colour Coded

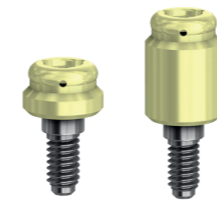

ANALOGUE

	3.0	NP	RP	WP
	3.0	3.5	4.5	5.7
	14.099	14.087	14.088	14.089

DESSLoc®

GH 1,0mm		88.087/1	88.088/1	
GH 2,5mm		88.087/2	88.088/2	
GH 3,5mm		88.087/3	88.088/3	
GH 4,5mm		88.087/4	88.088/4	
GH 5,5mm		88.087/5		

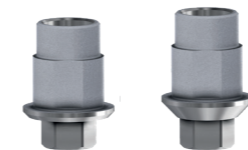

TI-BASE

GH 0,3mm	○		15.088	15.089
GH 0,8mm	○	15.087		
GH 0,3mm	⬡		16.088	16.089
GH 0,8mm	⬡	16.087		







TI-BASE CASTABLES

5 Pack.	○	32.001-P5	32.001-P5	32.001-P5
5 Pack.	⬡	33.001-P5	33.001-P5	33.001-P5



MULTI-UNIT ABUTMENTS

			3.0	NP	RP	WP
			3.0	3.5	4.5	5.7
GH 1,0mm	0°			40.087/1	40.088/1	
GH 2,0mm	0°			40.087/2	40.088/2	
GH 3,0mm	0°			40.087/3	40.088/3	
GH 4,0mm	0°			40.087/4		
GH 5,0mm	0°			40.087/5		

4.8
MULTI-UNIT PLATFORM

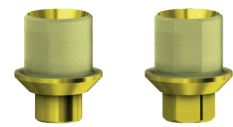

ANGLEBase®



			3.0	NP	RP	WP
			3.0	3.5	4.5	5.7
				36.087	36.088	36.089
				37.087	37.088	37.089

PLASTIC SLEEVES FOR ANGLEBase®

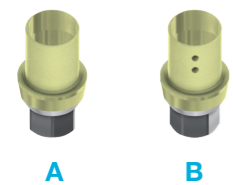
			3.0	NP	RP	WP
			3.0	3.5	4.5	5.7
	5 Pack.	0°		33.100-P5	33.100-P5	33.100-P5
	5 Pack.	10°		33.101-P5	33.101-P5	33.101-P5
	5 Pack.	20°		33.102-P5	33.102-P5	33.102-P5





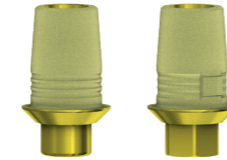

ELLIPTIBase®

			3.0	NP	RP	WP
			3.0	3.5	4.5	5.7
A corner				56.099		
B flat				57.099		



C-Base®

			3.0	NP	RP	WP
			3.0	3.5	4.5	5.7
GH 0,5mm				58.087	58.088	58.089
GH 3,0mm				58.087/3	58.088/3	58.089/3
GH 0,5mm				59.087	59.088	59.089
GH 3,0mm				59.087/3	59.088/3	59.089/3

Includes screw, same as standard screw.

Libraries available for EXOCAD & 3Shape.

Torx® Screw ANGLEBase® & ELLIPTIBase®



	3.0	NP	RP	WP
(replacement screw)	19.400	19.417	19.417	19.417
Recommended torque	30 Ncm	30 Ncm	30 Ncm	30 Ncm

Torx® BALL SCREWDRIVER



	20mm	24mm	30mm	35mm
	DT20TB06	DT24TB06	DT30TB06	DT35TB06

SCREW HEX 1,27mm



	3.0	NP	RP	WP
	19.043	19.043	19.043	19.043
Recommended torque	30 Ncm	30 Ncm	30 Ncm	30 Ncm

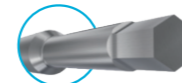

PRE-MILLED BLANK



	3.0	NP	RP	WP
	3.0	3.5	4.5	5.7
Ø 10mm Ti	61.099	61.087	61.088	61.089
Ø 14mm Ti			62.088	62.089

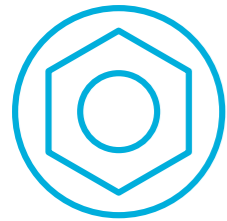

EXTERNAL HEX BH

compatible with
BioHorizons® External

- non-engaging
- engaging



SCAN ABUTMENTS

	NP	RP	WP
	3.7	4.2	5.2

52.020	52.021	52.022
--------	--------	--------



EXTISA extender for 52.xxx.



52.xxx includes manual tool DTPEIPEEK.



TRANSFER

17.020	17.021	17.022
--------	--------	--------

Transfers include two screws (for open and closed tray).



DIGITAL ANALOGUE

Retention screw Hex 1,27 mm 19.712-P5

14.020/D	14.021/D	14.022/D
----------	----------	----------



Platform Colour Coded



ANALOGUE

14.020	14.021	14.022
--------	--------	--------



Platform Colour Coded



CASTABLE

	28.020	28.021	28.022
	29.020	29.021	29.022

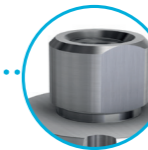

“Pull down and lock” holding system. Developed by DESS® back in 2012, allows a strong and precise positioning of the pre-milled blank inside its socket.

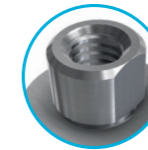

La parte superior de la Multi-unit DESS® es igual a la del Nobel System, independientemente del sistema elegido

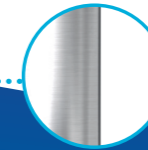

A total millable length of 20 mm makes it one of the longest in the market.

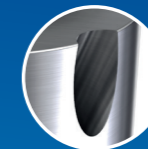

A total millable length of 20 mm makes it one of the longest in the market.

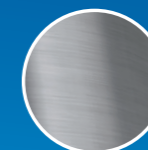

Titanium.



Minimal gingival transition height, just 0,3 mm to allow a maximum degree of design freedom.



DESS® connection precision is guaranteed in all our Premilled Blanks.



INTERNAL HEX MI

compatible with
Mis® Seven

○ non-engaging

⬡ engaging



	NP	SP	WP	Multi-Unit
HEALING ABUTMENT	3.3	3.75-4.2	5.0-6.0	4.8
GH 3,0mm		20.095/3	20.096/3	
GH 4,0mm		20.095/4	20.096/4	
GH 5,0mm		20.095/5	20.096/5	



SCAN ABUTMENTS

	NP	SP	WP	Multi-Unit
	52.056	52.095	52.096	52.085
EXTISA extender for 52.xxx.				
52.xxx includes manual tool DTPEIPEEK.				



TRANSFER

	NP	SP	WP	Multi-Unit
	17.056	17.095	17.096	
<i>Transfers include two screws (for open and closed tray).</i>				



DIGITAL ANALOGUE

	NP	SP	WP	Multi-Unit
Retention screw Hex 1,27 mm 19.712-P5	14.056/D	14.095/D	14.096/D	14.007/D ¹ 14.085/D ²
		¹ Standard Multi-unit		² MIS® Multi-unit



ANALOGUE

	NP	SP	WP	Multi-Unit
	14.056	14.095	14.096	14.007 ¹ 14.085 ²
10 Pack.		14.095-P10		14.007-P10
		¹ Standard Multi-Unit		² MIS® Multi-Unit



	NP	SP	WP	Multi-Unit
TEMPORARY ABUTMENT	3.3	3.75-4.2	5.0-6.0	4.8



	24.095	24.096	
	25.095	25.096	

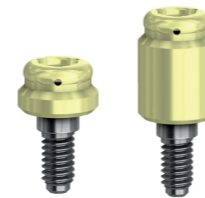

DESSLoc®

GH 1,0mm		88.095/1	88.096/1
GH 2,5mm		88.095/2	88.096/2
GH 3,5mm		88.095/3	88.096/3
GH 4,5mm		88.095/4	88.096/4
GH 5,5mm		88.095/5	



MULTI-UNIT ABUTMENTS

GH 1,0mm	0°	○	40.095/1	40.096/1
GH 2,0mm	0°	○	40.095/2	40.096/2
GH 3,0mm	0°	○	40.095/3	40.096/3
GH 4,0mm	0°	○	40.095/4	
GH 5,0mm	0°	○	40.095/5	
GH 2,5mm	17°	⬡	41.795/2	41.796/2
GH 3,5mm	17°	⬡	41.795/3	41.796/3
GH 3,5mm	30°	⬡	43.095/3	43.096/3
GH 4,5mm	30°	⬡	43.095/4	43.096/4

4.8
MULTI-UNIT PLATFORM

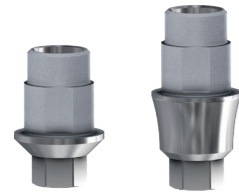

TI-BASE		NP	SP	WP	Multi-Unit
		3.3	3.75-4.2	5.0-6.0	4.8
	GH 0,3mm	○		15.096	
	GH 0,8mm	○	15.056	15.095	
	GH 1,5mm	○	15.256	15.295	15.296
	GH 3,0mm	○	15.356	15.395	15.396
	GH 0,3mm	⬡		16.096	
	GH 0,8mm	⬡	16.056	16.095	
	GH 1,5mm	⬡	16.256	16.295	16.296
	GH 3,0mm	⬡	16.356	16.395	16.396



TI-BASE CASTABLES					
5 Pack.	○	32.001-P5	32.001-P5	32.001-P5	32.001-P5
5 Pack.	⬡	33.001-P5	33.001-P5	33.001-P5	33.001-P5

SCREW HEX 1,27mm

	19.056	19.081	19.081	19.110
<i>Recommended torque</i>	<i>30 Ncm</i>	<i>30 Ncm</i>	<i>30 Ncm</i>	<i>30 Ncm</i>
				19.085
<i>Recommended torque</i>				<i>15 Ncm</i>

PRE-MILLED BLANK

Ø 10mm	Ti	61.056	61.095	61.096
Ø 14mm	CoCr			71.096

CoCr BASE

	○	30.056	30.095	30.096
	⬡	31.056	31.095	31.096

CASTABLE

	○	28.056	28.095	28.096
	⬡	29.056	29.095	29.096

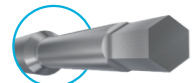

The importance of a precise image





CONIC MC

compatible with
Mis[®] C1 internal

-  non-engaging
-  engaging



SCAN ABUTMENTS

	NP	SP	WP	Multi-Unit
	52.081	52.082	52.083	52.085 <i>MIS</i>



EXTISA extender for 52.xxx.



52.xxx includes manual tool DTPEIPEEK.



TRANSFER

17.081	17.082	17.083
--------	--------	--------

Transfers include two screws (for open and closed tray).



DIGITAL ANALOGUE



Platform Colour Coded

Retention screw Hex 1,27 mm 19.712-P5

14.081/D	14.082/D	14.083/D	14.007/D ¹
			14.085/D ²

¹ Standard Multi-Unit

² MIS[®] Multi-Unit



ANALOGUE



Platform Colour Coded

14.081	14.082	14.083	14.007 ¹
			14.085 ²

¹ Standard Multi-Unit

² MIS[®] Multi-Unit



SCREW HEX 1,27mm

	19.056	19.081	19.081	19.110 <i>MIS</i>
Recommended torque	30 Ncm	30 Ncm	30 Ncm	30 Ncm

Recommended torque

15 Ncm

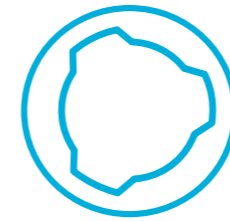

CONIC MV

compatible with
Mis[®] V3

-  non-engaging
-  engaging



SCAN ABUTMENTS

	NP	SP	Multi-Unit
	52.084	52.082	52.085 <i>MIS</i>



EXTISA extender for 52.xxx.



52.xxx includes manual tool DTPEIPEEK.



TRANSFER

17.084	17.082
--------	--------

Transfers include two screws (for open and closed tray).



Platform Colour Coded

DIGITAL ANALOGUE

Retention screw Hex 1,27 mm 19.712-P5

14.084/D	14.082/D	14.007/D ¹
		14.085/D ²

¹ Standard Multi-Unit

² MIS[®] Multi-Unit



Platform Colour Coded

ANALOGUE

14.084	14.082	14.007 ¹
		14.085 ²

¹ Standard Multi-Unit

² MIS[®] Multi-Unit



SCREW HEX 1,27mm

	19.056	19.081
Recommended torque	30 Ncm	30 Ncm

Recommended torque

15 Ncm



CONIC ANYR

compatible with
Megagen AnyRidge®

-  non-engaging
-  engaging



SCAN ABUTMENTS

	EXTISA extender for 52.xxx.	52.057
	52.xxx includes manual tool DTPEIPEEK.	



TRANSFER

		17.057
<i>Transfers include two screws (for open and closed tray).</i>		



DIGITAL ANALOGUE

Retention screw Hex 1,27 mm	19.712-P5	14.057/D
-----------------------------	-----------	----------

 Platform Colour Coded

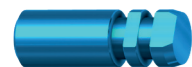





ANALOGUE

		14.057
--	--	--------

 Platform Colour Coded



TI-BASE

GH 2,0mm		15.057
GH 3,0mm		15.357
GH 2,0mm		16.057
GH 3,0mm		16.357



TI-BASE CASTABLES

5 Pack.		32.001-P5
5 Pack.		33.001-P5

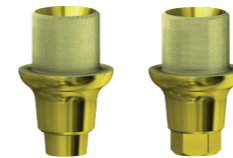

ANGLEBase®

	36.057
	37.057

PLASTIC SLEEVES FOR ANGLEBase®

	5 Pack.	0°	33.100-P5
	5 Pack.	10°	33.101-P5
	5 Pack.	20°	33.102-P5



Torx® Screw ANGLEBase®

(replacement screw)	19.460
Recommended torque	35 Ncm



Torx® BALL SCREWDRIVER

	20mm	24mm	30mm	35mm
	DT20TB06	DT24TB06	DT30TB06	DT35TB06

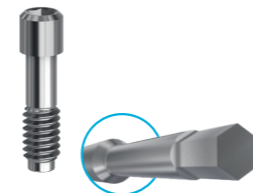

SCREW HEX 1,20mm

	19.057
Recommended torque	35 Ncm



PRE-MILLED BLANK

Ø 10mm	Ti	61.057
Ø 14mm	CoCr	71.057



CONIC DENT

compatible with
Dentium Superline™ & Implantium®

○ non-engaging
⬡ engaging



SCAN ABUTMENTS

RP				
3.6	3.8	4.0	4.5	5.0

52.090



EXTISA extender for 52.xxx.



52.xxx includes manual tool DTPEIPEEK.



TRANSFER

17.090

Transfers include two screws (for open and closed tray).



Platform Colour Coded

DIGITAL ANALOGUE

Retention screw Hex 1,27 mm 19.712-P5

14.090/D



Platform Colour Coded

ANALOGUE

14.090



MULTI-UNIT ABUTMENTS

RP				
3.6	3.8	4.0	4.5	5.0

GH 1,5mm	0°	○		40.090/1
GH 2,5mm	0°	○		40.090/2
GH 3,5mm	0°	○		40.090/3

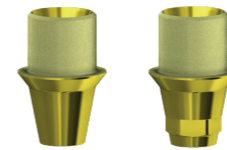

ANGLEBase®

○	36.090
⬡	37.090

PLASTIC SLEEVES FOR ANGLEBase®

	5 Pack.	0°	33.100-P5
	5 Pack.	10°	33.101-P5
	5 Pack.	20°	33.102-P5



CASTABLE

○	28.090
⬡	29.090

MULTI-UNIT CONNECTION

○ non-engaging

HEALING ABUTMENT		RP 4.8	MULTI-UNIT	WP 6
Uni Grip	○	20.100		20.054
Hex 1,20mm	○	20.100H120		
Hex 1,22mm	○	20.100H122		
Hex 1,27mm	○	20.100H127		



SCAN ABUTMENTS

	50.007		
	52.007		52.047

EXTISA extender for 52.xxx.

52.xxx includes manual tool DTPEIPEEK.

TRANSFER

		17.007		17.050
5,0mm		17.507		
5,0mm	4 Pack.	17.507-P4		
8,0mm		17.807		
8,0mm	4 Pack.	17.807-P4		



DIGITAL ANALOGUE

Retention screw Hex 1,27 mm 19.712-P5

14.007/D

14.047/D



Platform Colour Coded



Platform Colour Coded

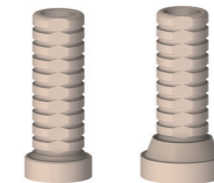

ANALOGUE

10 Pack.

RP
4.8
14.007

MULTI-UNIT

WP
6
14.047

14.007-P10

TEMPORARY ABUTMENT

Uni Grip		○	24.007	24.030
Hex 1,20mm		○	24.007H120 19.055	
Hex 1,22mm		○	24.007H122 19.065	
Hex 1,27mm		○	24.007H127 19.110	

TEMPORARY ABUTMENT PEEK

Uni Grip		○	25.707	25.754
----------	--	---	--------	--------

TI-BASE

6,0mm	Uni Grip		○	15.007	15.054
6,0mm	Uni Grip		○	15.007-P10	
6,0mm	Hex 1,20mm		○	15.007H120 19.055	
6,0mm	Hex 1,22mm		○	15.007H122 19.065	
6,0mm	Hex 1,27mm		○	15.007H127 19.110	
8,0mm	Uni Grip		○	15.007/8	



TI-BASE CASTABLES

5 Pack.	○	32.007-P5	32.054-P5
5 Pack.	○	32.007/8-P5	



			RP 4.8	WP 6
ANGLEBase®				
		○	36.007	36.054
10 Pack.		○	36.007-P10	

PLASTIC SLEEVES FOR ANGLEBase®

	5 Pack.	0°	33.700-P5	
	5 Pack.	10°	33.701-P5	
	5 Pack.	20°	33.702-P5	

Torx® Screw ANGLEBase®



(replacement screw)			19.306	
Recommended torque			15 Ncm	15 Ncm

Torx® BALL SCREWDRIVER



	20mm	24mm	30mm	35mm
	DT20TB06	DT24TB06	DT30TB06	DT35TB06

SCREWS FOR SUPERSTRUCTURES

	10 Pack.		Torx®	19.069-P10	
	10 Pack.	DLC	Torx®	19.269-P10	
	10 Pack.		Hex 1,20mm	19.093-P10	
	10 Pack.		Hex 1,22mm	19.094-P10	
	10 Pack.		Hex 1,27mm	19.095-P10	
	10 Pack.		UG	19.096-P10	
Recommended torque				20 Ncm	



			RP 4.8	WP 6
SCREW UG				
			19.006	19.031
10 Pack.			19.006-P10	
			19.206	19.231



			Hex 1,20mm	19.055	
			Hex 1,22mm	19.065	
			Hex 1,27mm	19.110	
Recommended torque				15 Ncm	15 Ncm

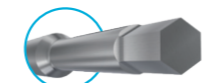

DESSLoc®



			88.007	
--	--	--	--------	--

CoCr BASE



6,0mm		○	30.007	30.054
-------	--	---	--------	--------

CASTABLE



		○	28.007	28.054
10 Pack.		○	11.007-P10	11.054-P10



SCAN ABUTMENTS



53.153

10 Pack.

53.153-P10



TRANSFER

17.054

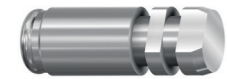

ANALOGUE

14.054



Platform Colour Coded

10 Pack.

14.054-P10



BAR ATTACHMENT

88.100

RETENTION KITS



0° - 20° x1

DLRKL-P1

0° - 20° x2

DLRKL-P2



0° - 40° x1

DLERL-P1

0° - 40° x2

DLERL-P2

MALES



0° - 20° x4

1.5 lbs / 680g

DLN2L-P4



0° - 20° x4

3.0 lbs / 1360g

DLN3L-P4



0° - 20° x4

5.0 lbs / 2270g

DLN4L-P4



0° - 40° x4

1.5 lbs / 450g

DLN1L-P4



0° - 40° x4

2.0 lbs / 910g

DLN6L-P4



0° - 40° x4

4.0 lbs / 1810g

DLN7L-P4

SPECIAL TOOLS



Direct to torque wrench Nobel Biocare™

DTACTLOC



Direct to torque wrench Straumann®

DTSTRLOC



DESSLoc® tool for square torque wrench

DTLOC



Adaptor from Straumann® torque wrench to square connection

DTSTSQ



Nobel Biocare™ Adapter from 8mm to square connection



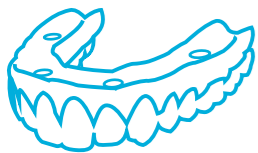

DTNBSQ



DESS CLEAN FIT

NEW

DESS CLEAN FIT

	1 x removal mechanism (includes removal pin) 3 x retentive caps	1611
	2 x removal mechanism (include removal pin) 2 x retentive caps	1611A
	2 x retentive caps	1611B
	1 x Removal pin	1611C

DESS CLEAN FIT Abutments

Fixed yet removable The best of both worlds

- Fixed restoration feel.
- Friction fit easy to remove.
- No plastic inserts.
- No bone loss.*
- periocoat® Surface treatment (DESS patented ZrN coating).
- Patented female caps with release system.
- Compatible with Atlantis® conus concept and Syncone®.

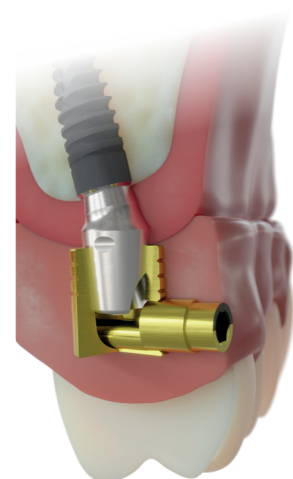

*Compared to standard removable overdentures.



PURE SWITCH *by* DESS®
 “simple switch, perfect connection”

All DESS® products are based on the “Pure Switch” philosophy, a concept which guarantees the interchangeability of abutments without having to switch tools or protocols.

This philosophy ensures that all DESS® abutments are interchangeable with any abutment of any implant brand.

- Guaranteed quality.



- Lifetime warranty¹.
- 100% compatibility.
- CAD/CAM libraries available.
- More than 30 connections from a single supplier.

¹To find out more about DESS lifetime warranty download it on our website.

HOLDERS



HLDSTD

For standard
98mm disc machines

Most industrial milling machine
with a 98mm disc holder:
Arum
Dmg
Datron
Haas
Robodril



HLDVHFR5

For VHF®

VHF® R5

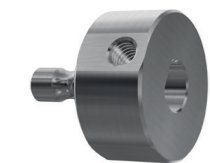

HLDVHFZ4

For VHF®

VHF® Z4



HLDIMES

For Imes-Icore® machines

Coritec 150i pro
Coritec 245i touch
Coritec 250i touch
Coritec 350i / Coritec 250i Loader
Coritec 450i
Coritec 550i
Coritec 650i / Coritec 650i Loader



HLDYENA

For Yenadent®

D6
D15
D43N

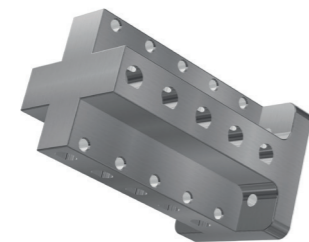

HLD3R

For machines with
support / changer 3R

D14P



HLDVHF

For VHF®

VHF® S1
VHF® S2
VHF® S5



HLDVHFN4

For VHF®

VHF® N4



AK-1 ROLAND

DESS premills are compatible
with AK-1 Holder, developed
and supplied by ROLAND.

ANGLE MILLING TOOL

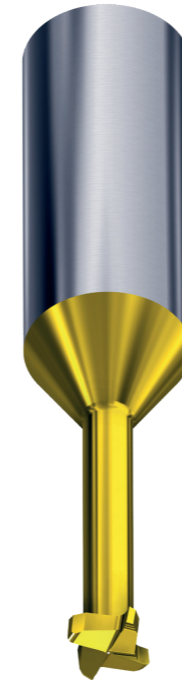

	ØA	ØB	ØC	L1	L2	L3	R
MT3D16L5	3	1,6	0,95	5	51	0,5	0,1
MT4D16L5	4	1,6	0,95	5	51	0,5	0,1
MT6D16L5	6	1,6	0,95	5	51	0,5	0,1

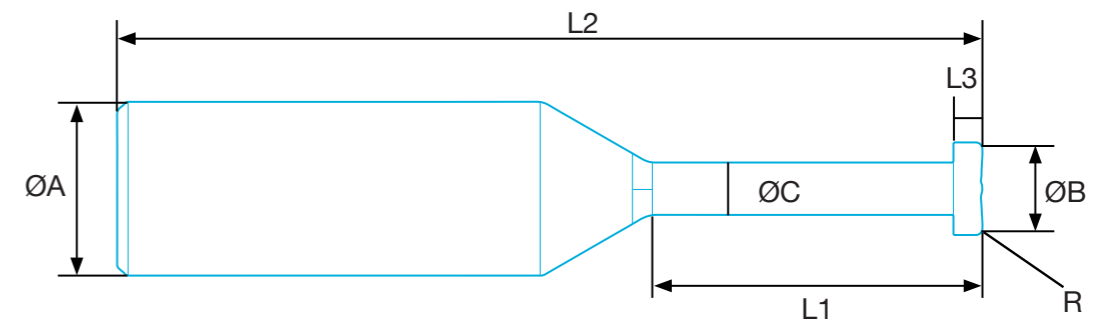

BLOCKS



Ti	□ 15mm	L 20mm	63.020
Ti	□ 15mm	L 40mm	63.040
CoCr	□ 15mm	L 20mm	73.020
CoCr	□ 15mm	L 40mm	73.040

TOOLS

SCREWDRIVERS TIPS

HEX	18mm	20mm	24mm	30mm	35mm	compatible with
0,90mm		DTC20H090	DTC24H090			Neodent® CM
1,00mm		DTC20H100	DTC24H100		DTC35H100	Dentsply Ankylos® C/X
1,20mm	DTC18H120	DTC20H120	DTC24H120	DTC30H120	DTC35H120	3i Osseotite®, 3iCertain®, Megagen AnyRidge®
1,22mm		DTC20H122	DTC24H122		DTC35H122	Dentsply Friadent Xive®, Osstem® TS, GlobalD®, BTI®, Biotech Kontakt®
1,25mm		DTC20H125	DTC24H125			
1,27mm		DTC20H127	DTC24H127	DTC30H127	DTC35H127	Astra tech™, OsseosSpeed™, Zimmer Screw-Vent® & Mis® Seven/C1 & V3, BioHorizons®, AstraTech Implants System EV™, Camlog®, Bego Semados®, Conelog®
1,30mm		DTC20H130	DTC24H130			
1,50mm		DTC20H150	DTC24H150			
1,70mm		DTC20H170	DTC24H170			
1,75mm		DTC20H175	DTC24H175			Astra tech™ EV, Uniabutment®

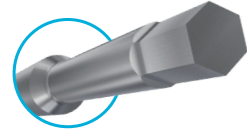

Torx® 06



Torx® ball

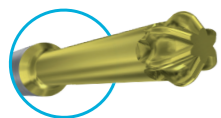

UG

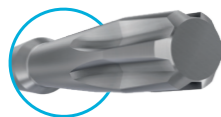

UG	18mm	20mm	24mm	30mm	35mm	
		DT20U	DT24U	DT30U	DT35U	Nobel Brånemark®, NobelReplace® Select™, NobelActive™ & NobelReplace® CC, Multi-unit®



NEO 18mm 20mm 24mm 30mm 35mm compatible with

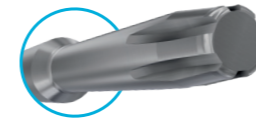

Square

1,30mm	DT20S130	DT24S130
--------	----------	----------

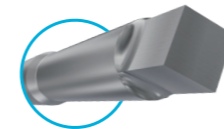

SCREWDRIVER HANDLES



Dentist handle

	21mm		28mm	
	Straumann® ratchet ø7mm	Nobel® ratchet ø8mm	Straumann® ratchet ø7mm	Nobel® ratchet ø8mm
HEX 1,20mm	WSDSTL21H120	WSDNBL21H120	WSDSTL28H120	WSDNBL28H120
HEX 1,25mm	WSDSTL21H125	WSDNBL21H125	WSDSTL28H125	WSDNBL28H125
UG	WSDSTL21UG	WSDNBL21UG	WSDSTL28UG	WSDNBL28UG
Torx® 06	WSDSTL21TC06	WSDNBL21TC06	WSDSTL28TC06	WSDNBL28TC06
Torx® ball	WSDSTL21TB06	WSDNBL21TB06	WSDSTL28TB06	WSDNBL28TB06

Premium laboratory handle



PHLABGOLD





PHLABBLACK

DESSLoc® Removal & Insertion Tool





PHLOC

TI-BASE EXTRACTING TOOL

	For Conelog® NP/RP	DCCON
	For Conelog® WP	DCCON50
	For ZIMMER SCREW-VENT®	DCZIM
	For Medentis ICX®	DCICX

















TORQUE WRENCH TOOL

	Type Straumann® 7mm	DTSTTW
	Type Nobel® 8mm	DTNBTW

TRAY MULTI-USE

	BOX1
--	------

SPECIAL TOOLS

	Multi-unit® RP	DTMURP
	Multi-unit® WP	DTMUWP
	UniAbutment® (Astra Tech osseospeed™)	DTUNI
	Octagon	DTSYN
	Torque wrench adaptor	TWADAP
	DESSLoc® Tool for square connection	DTLOC
	Adaptor from 7mm to Straumann® torque wrench to square connection	DTSTSQ
	Screwdriver tips adaptor from Straumann® torque wrench	DTSTWH
	Direct to torque wrench Nobel Biocare™ 8mm	DTACTLOC
	Direct to torque wrench Straumann® 7mm	DTSTRLOC
	Straumann® contra-angles adapter	DTSTCA
	Nobel Biocare™ adapter from 8mm to square connection	DTNBSQ
	Screwdriver tips adaptor from Nobel Biocare™ torque wrench	DTNBWH
	Nobel Biocare™ contra-angles adapter	DTNBCA
	Handpiece adaptor for Square connection	DTANGSQ
	Manual driver for Intraoral Scan abutment	DTPEI
	Manual tool for Intraoral Scan abutment	DTPEIPEEK-P2

SCREWS FOR STRUCTURES

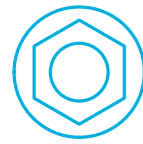

Nobel Brånemark® External Hex Universal	NP/3.5 Screw UG	For structures	19.101
			19.101-P10 <i>Pack of 10</i>

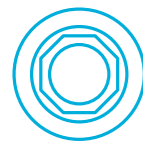

Straumann® Soft Tissue Level & SynOcta® Octagon	RN/WN Screw TORX®	For structures on implant	19.102
			19.102-P10 <i>Pack of 10</i>
Straumann® Soft Tissue Level & SynOcta® Octagon	RN/WN Screw TORX®	For structures on abutment	19.103
			19.103-P10 <i>Pack of 10</i>

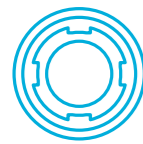

Straumann® Bone Level Conical BL	NC/RC Screw TORX®	For structures	19.104
			19.104-P10 <i>Pack of 10</i>
Straumann® Bone Level Conical BL	NC/RC Screw TORX®	For structures on Multi-Base	19.105
			19.105-P10 <i>Pack of 10</i>

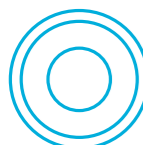

MULTI-UNIT 3i	Multi-Unit connection Sxrew Hex 1,20	For 3i	19.106
			19.106-P10 <i>Pack of 10</i>

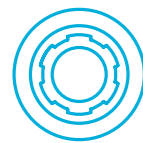

Dentsply ANKYLOS® C/X Internal ANK	Sxrew Hex 1,00	For structures on abutment	19.349
--	----------------	----------------------------	--------



MULTI-UNIT		RP/4.8 Screw Torx®	For structures	19.069-P10 <i>Pack of 10</i>
		19.269-P10 <i>DLC Pack of 10</i>		
MULTI-UNIT		RP/4.8 Hex 1,20mm	For structures	19.093-P10 <i>Pack of 10</i>
		RP/4.8 Hex 1,22mm		19.094-P10 <i>Pack of 10</i>
		RP/4.8 Hex 1,27mm		19.095-P10 <i>Pack of 10</i>
MULTI-UNIT		RP/4.8 Screw UG	For structures	19.096-P10 <i>Pack of 10</i>



DESS® DESIGN: FLAT SEAT

FLAT SEAT ADVANTAGES

- Allows for higher preload/clamping force between the structure and MUA.
- More forgiving of inaccuracies in internal milling of screw seat.
- Version with DLC coating to reduce friction and further increase preload/clamping force.
- Length of screw allows for more structure material under the screw-seat to strengthen both zirconia and temporary structures.
- Flat seat is self-centering and allows for a more forgiving alignment between diverging long-axis of the structure and MUA
- Torx connection compatible with DESS® Torx® ball screwdriver for angled screw channels.





CLINICAL SCREWS RECOMMENDED TORQUE

**NOBELACTIVE® &
NOBELREPLACE® CC**
ACTIVE HEX



PLATFORM SIZE	DESS REF. N°	DESS RECOMMENDED TORQUE (Ncm)	ORIGINAL EQUIVALENT REF. N°
3.0	19.068	15	Nobel Biocare® 36805
NP	19.027	35	Nobel Biocare® 31168
NP	19.227	35	Nobel Biocare® 29282
NP	19.101	35	
NP	19.327	35	
NP ANGLEBase®	19.441	35	
RP	19.030	35	Nobel Biocare® 28815
RP	19.230	35	Nobel Biocare® 36918
RP	19.328	35	
RP ANGLEBase®	19.442	35	
On1®	19.021	35	Nobel Biocare® 38751
On1®	19.221	35	Nobel Biocare® 38750
NP on implant for Multi-unit®	19.507	35	
RP on implant for Multi-unit®	19.508	35	
NP	19.004	35	Nobel Biocare® 31170
NP	19.204	35	Nobel Biocare® 36818
NP	19.304	35	
NP ANGLEBase®	19.404	35	
RP/WP/6.0	19.005	35	Nobel Biocare® 29293
RP/WP/6.0	19.205	35	Nobel Biocare® 29475
RP/WP/6.0	19.305	35	
RP/WP ANGLEBase®	19.405	35	
NP on implant for Multi-unit®	19.504	35	
RP on implant for Multi-unit®	19.505	35	

**NOBELREPLACE
SELECT™**
TRI-LOBE



NOBEL BRÅNEMARK®
EXT HEX UNIVERSAL



PLATFORM SIZE	DESS REF. N°	DESS RECOMMENDED TORQUE (Ncm)	ORIGINAL EQUIVALENT REF. N°
NP	19.027	35	Nobel Biocare® 31168
NP	19.227	35	Nobel Biocare® 29282
NP	19.327	35	
NP	19.101	35	
NP ANGLEBase®	19.401	35	
RP	19.028	35	Nobel Biocare® 29290
RP	19.228	35	Nobel Biocare® 29283
RP	19.328	35	
RP ANGLEBase®	19.402	35	
WP	19.029	35	Nobel Biocare® 31169
WP	19.229	35	Nobel Biocare® 29284
WP	19.329	35	
NP on implant for Multi-unit®	19.501	35	
RP on implant for Multi-unit®	19.502	35	
NP/RP/WP	19.034	20	Biomet 3i® UNIHT
NP/RP/WP	19.634	20	
NP/RP/WP ANGLEBase®	19.402	20	
RP on implant for Multi-unit®	19.512	20	
Low Profile® Abutment ø4.8	19.106	10	Biomet 3i® LPCTSH
NP/RP/WP	19.011	20	Biomet 3i® IUNIHT
NP/RP/WP	19.311	20	
NP/RP/WP	19.611	20	
NP/RP/WP ANGLEBase®	19.438	20	
Low Profile® Abutment ø4.8	19.106	10	Biomet 3i® LPCTSH
NNC	19.070	35	Straumann® AG 048.314
NNC	19.670	35	
RN/WN on implant	19.026	35	Straumann® AG 048.356
RN/WN on implant	19.102	35	Straumann® AG 049.181
RN/WN on implant	19.328	35	
RN/WN ANGLEBase®	19.446	35	
RN/WN on synOcta® abutment	19.009	15	Straumann® AG 048.350

3i CERTAIN®
EXT HEX USA



3i OSSEOTITE®
INT HEX CLICK



**STRAUMANN® SOFT
TISSUE LEVEL &
SynOcta®**
OCTAGON



**STRAUMANN®
BONE LEVEL**

CONICAL BL



PLATFORM SIZE	DESS REF. N°	DESS RECOMMENDED TORQUE (Ncm)	ORIGINAL EQUIVALENT REF. N°
NC on implant	19.032	35	Straumann® AG 025.2908
RC on implant	19.033	35	Straumann® AG 025.4908
NC/RC on implant	19.037	35	Straumann® AG 025.4900
NC/RC on implant	19.104	35	Straumann® AG 025.4906
NC/RC on implant	19.311	20	
NC/RC ANGLEBase®	19.443	35	
NC/RC on implant for Multi-unit®	19.544	35	
NC/RC on Multi-base® abutment	19.041	15	Straumann® AG 025.0900-04
NC/RC on Multi-base® abutment	19.105	15	
NC/RC on SRA® abutment	19.098	15	Straumann® AG 023.4763

**STRAUMANN®
BLX**

CONICAL BLX



RB/WB	19.054	35	
RB/WB ANGLEBase®	19.441	35	

**NEODENT®
GRAND MORSE®**

NEO GM



GM	19.051	20	
GM ANGLEBase®	19.444	20	

**ZIMMER
SCREW-VENT®**

INT HEX USA



NP/RP/WP	19.012	30	Zimmer® URS2
NP/RP/WP	19.042	30	Zimmer® MHLAS
NP/RP/WP	19.312	30	
NP/RP/WP ANGLEBase®	19.417	30	
NP (MIS®)	19.327	35	
NP on implant for Multi-unit®	19.519	30	
RP on Multi-unit® abutment ø4.8	19.110	15	
RP on Multi-unit® abutment ø4.8	19.300	15	

**ASTRA TECH
IMPLANT
SYSTEM™ EV**

CONIC EVO



PLATFORM SIZE	DESS REF. N°	DESS RECOMMENDED TORQUE (Ncm)	ORIGINAL EQUIVALENT REF. N°
3.6 ANGLEBase®	19.441	25	
4.2 ANGLEBase®	19.460	25	
4.8 ANGLEBase®	19.461	25	
UniAbutment® EV	19.058	15	

**ASTRA TECH
OSSEOSPEED™**

INT HEX CONIC



NP on implant	19.015	15	Dentsply® 24189
RP on implant	19.016	20	Dentsply® 24449
RP ANGLEBase®	19.441	20	
WP on implant	19.017	25	Dentsply® 24209
WP ANGLEBase®	19.425	25	
UniAbutment® 20°/45°	19.018	15	Dentsply® 22435

**DENTSPLY
FRIADENT XIVE®**

INT HEX FD



NP/RP/WP	19.024	24	Dentsply® 454305
NP/RP/WP ANGLEBase®	19.438	24	

**DENTSPLY
ANKYLOS® C/X**

INT ANK



All platforms	19.048	15	
All platforms	19.050	15	

OSSTEM® TS
CONIC OSS



PLATFORM SIZE	DESS REF. N°	DESS RECOMMENDED TORQUE (Ncm)	ORIGINAL EQUIVALENT REF. N°
Mini on implant	19.072	20	
Mini ANGLEBase®	19.444	20	
Standard on implant	19.073	30	Osstem® GSABSST
Standard ANGLEBase®	19.461	30	
3,3 / 3,8 / 4,3 on implant	19.044	20	
3,8 / 4,3 ANGLEBase®	19.444	20	
5.0 on implant	19.045	20	Camlog® J4005. 2001

CAMLOG®
INT CAM



BIOHORIZONS® INTERNAL
INT HEX BH



On implant	19.043	30	BioHorizons® PXAS
On implant	19.043	30	
Multi-unit® RP ø4.8	19.006	15	Nobel Biocare® 29287
Low Profile® abutment ø4.8	19.106	10	Biomet 3i® LPCTSH
Multi-unit® RP ø4.8	19.110	15	
Multi-unit® RP ø4.8	19.206	15	Nobel Biocare® 29285
Multi-unit® RP ø4.8 ANGLEBase®	19.306	15	
MIS® Multi-unit® RP ø4.8	19.300	15	
Multi-unit® WP ø6.0	19.031	15	Nobel Biocare® 31163
Multi-unit® WP ø6.0	19.231	15	Nobel Biocare® 29286

BIOHORIZONS® EXTERNAL

EXT HEX BH



MIS® SEVEN

INT HEX MI



MEGAGEN AnyRidge®

CONIC ANYR



PLATFORM SIZE	DESS REF. N°	DESS RECOMMENDED TORQUE (Ncm)	ORIGINAL EQUIVALENT REF. N°
NP	19.312	30	
RP/WP	19.328	35	
NP	19.056	30	
SP/WP ANGLEBase®	19.417	30	
All platforms	19.057	35	
All platforms ANGLEBase®	19.460	35	





All DESS products are manufactured according to ISO 9001 and ISO 13485 with CE marking for all products Class IIb IIa

All DESS® ANGLEBase® screws and screwdrivers are based on the standard ISO 10664
3i® and 3i Certain®, Miniplant®, MicroMiniplant™ and Osseotite® are registered trademarks of 3i Implant Innovations, USA

ASTRA TECH™, OsseoSpeed™, ANKYLOS® C/X, XiVE®, FRIADENT®, ASTRATECH implant system™ EV and UniAbutment®

Cerec® are registered trademarks of DENTSPLY SIRONA Implants

BioHorizons® is a registered trademark of BioHorizons, INC.

Brånemark System®, NobelReplace® and Replace Select™, NobelActive™, NobelReplace® CC, NobelSpeedy™ and Multi-unit® are registered trademarks of Nobel Biocare AB,

Neodent®, Grand Morse®, Straumann® and synOcta® are registered trademarks of Straumann Holding AG, Switzerland

MIS® is a registered trademark of MIS Implant Technologies Ltd.

Zimmer Screw-Vent® and SwissPlus® are registered trademarks of Zimmer Dental INC, USA

Dyna® is a registered trademark of Dyna Dental Engineering BV

Locator® is a registered trademark of ZEST IP Holdings

Camlog® and Conelog® are registered trademarks of CAMLOG Biotechnologies AG

Megagen® is a registered trademark of MEGAGEN IMPLANT CO. LTD

TORX® is a trademark of ACUMENT INTELLECTUAL PROPERTIES, LLC

Bego Semados® is a registered trademark of BEGO GmbH & Co. KG

Anthogyr® is a registered trademark of Anthogyr SAS

Medentis ICX® is a registered trademark of medentis medical GmbH

Osstem®, Hiossen® is a registered trademark of OSSTEM IMPLANT CO. LTD

Dentium® is a trademark of Dentium Co. Ltd.

GOBALD® is a trademark of Global D SASU.

Biotech Kontakt® is a trademark Biotech Dental SAS.

BTI® is a trademark BTI Biotechnology Institute.

PHIBO® is a trademark PHIBO Dental Solutions S.L.

DESS products can be used only by licensed dentists, physicians and labs.

Please refer ever to the instructions for use available on the website

www.dess-usa.com

or supplied with the product.

Some products may not be available in your country. Some of the products are cleared for US and Canada.

Please contact your local distributor for more details.



Health Canada
Medical Device Licenses
94512 & 107023





www.dess-usa.com