



DESS

> DENTAL SMART SOLUTIONS

Catalogue Digital Workflow 2024



Digital Workflow

Technology has completely transformed the way we understand the world. Following the same dynamics, dentistry has evolved and technology has significantly improved the way we organise our work as well as giving dentists and lab technicians cutting-edge technology to transform the profession and to personalise treatments.

In this perspective, thanks to digital Impressions, CAD design and 3D printing, we can now have a perfect reproduction of a patient's mouth within a matter of hours, a process which used to take several days.

Efficiency:

Digitalization has improved efficiency in all procedures. An easy 3D scan reduces labour, chair time and the logistics of shipping the impressions to the lab, not to mention the possibility of checking those scans and making any corrections with the patient still in the practice.

Personalization:

No two dental cases are the same. Each treatment is tailored and equipment such as 3D scanners or milling machines guarantee high-quality custom products with excellent results.

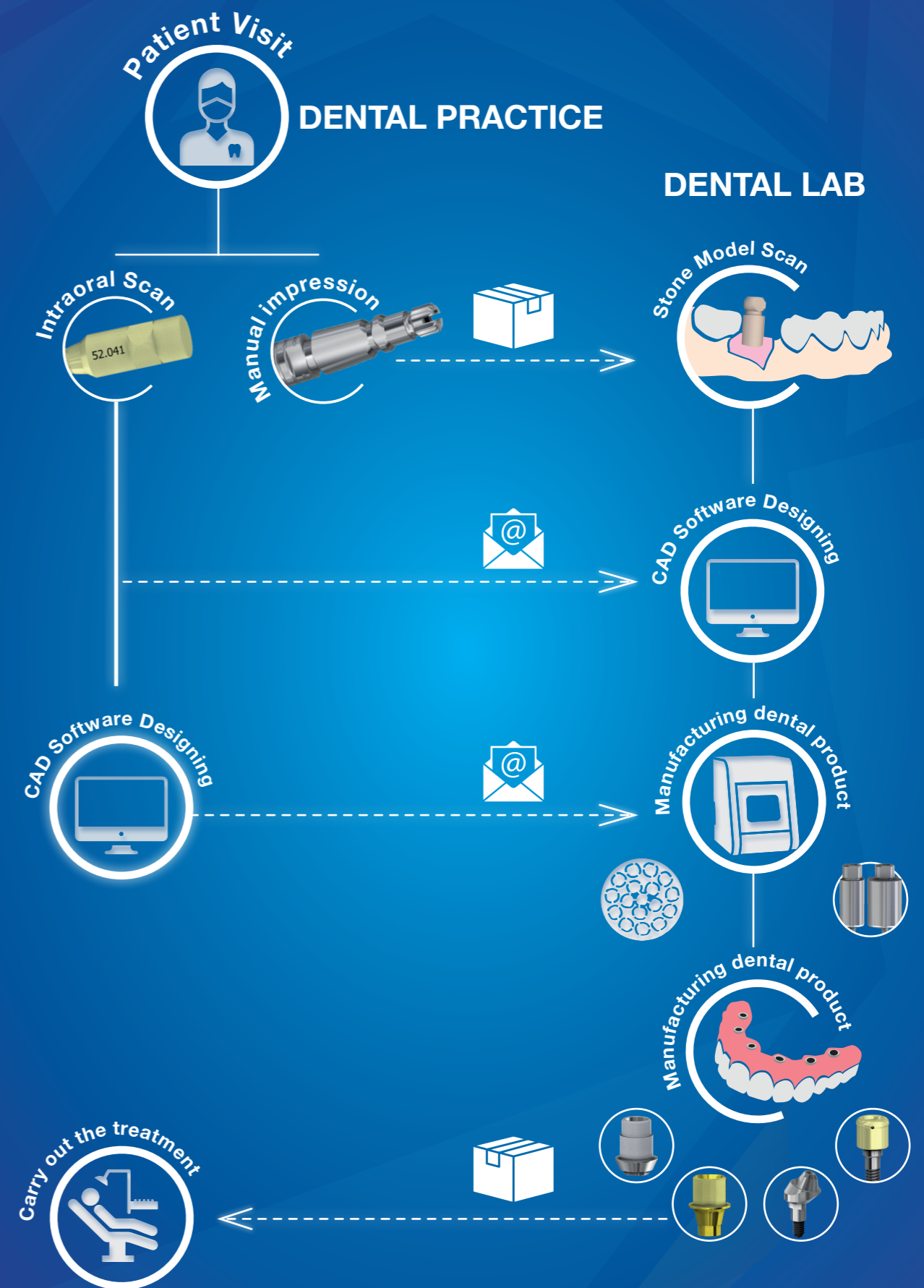

Products



Intraoral Scan Abutment:

- ZrN coating treatment.
- Durable – Radiopaque.
- Spray-free, no glitter due to surface treatment.
- Can be tightened by hand or with a special tool, no screwdrivers needed.
- No distortion - No screw hole.



Transfer:

Body manufactured in Stainless Steel AISI 303 with titanium grade 5 ELI and with opened/closed tray screws. The DESS® Transfers have a flat face to avoid rotation and improve retention inside the silicone.

The screw head can be used with the specific system screwdriver; flat tool (like a dental spatula) or manually. Their 1 mm horizontal positioning marks facilitate locating the implant head.



Ti-Base:

DESS® Ti-Bases are a great choice for your restorations. Made of Titanium grade V ELI, a short chimney to improve aesthetic results and SelectGrip® surface treatment for up to 500% more bond retention.

- Engaging and non-engaging versions are available.
- Available in 32 compatibilities.
- Available in different gingival heights.

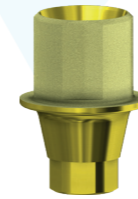

ANGLEBase®:

ANGLEBase® is our angulated screw channel solution. Made of Titanium grade V ELI, with a gold coating that creates a warmer gingival tone and SelectGrip® treatment.

- Engaging and non-engaging versions are available.
- Available in 23 compatibilities.
- Up to 25° screw channel insertion with 360° angular freedom.
- Library available for 0.045 and 0.02 cement gaps.

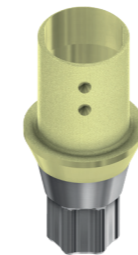

ELLIPTIBase®:

ELLIPTIBase® is the angular solution for narrow interdental spaces. Made of Titanium grade V ELI, with SelectGrip® surface and ZrN coating to reduce plaque adhesion and increase the strength. It is 22% smaller than a standard Ti-Base, providing the same cementation area.

- Available in engaging version.
- Available in 6 compatibilities.
- Angulation of up to 20° bi-directional.
- Available in 2 versions: Corner and flat - depending on the screw channel insertion.



C-Base®:

C-Base is our Sirona Cerec system compatible solution. Made of Titanium grade 5 ELI, with a gold anodized surface and SelectGrip® the C-Base® is the most complete alternative.

- Engaging and non-engaging versions are available.
- Available in 15 compatibilities.
- Available in different gingival heights.
- Integrated into EXOCAD® and 3SHAPE®. It can be used in 3rd party systems.

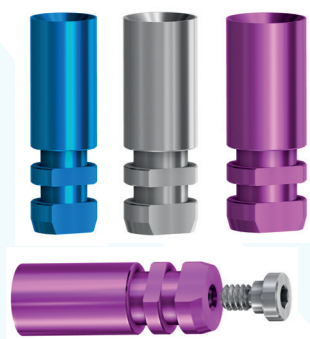

Digital Analogues:

Manufactured in Titanium grade V ELI, anodized (colour coded to match the platform) and Stainless steel (not coloured). Self-locking for great stability in stone models, and it can be used in 3D models.

Our specially designed 3D Analogue comes with a hex screw to guarantee that the analogue is positioned at the bottom of the model.

- Available in 32 compatibilities.



Multi-Unit:

DESS offers the most comprehensive range of Multi-unit abutments, which are perfect for partial and full arch restorations. Available in Straight version, non-engaging and Angled version engaging.

- Available in 14 compatibilities.
- Available in 5 different gingival heights.
- Angled version has two different models, 17° angulation or 30° angulation to adapt to almost every clinical case.



DESSLoc®:

DESSLoc® comprises our overdenture attachments for removable prosthesis. Made of Titanium grade V ELI topped with ZrN coating to increase the strength, reduce plaque adhesion and inflammation without compromising the mechanical performance.

- Available in 14 compatibilities.
- Two different processing retention kits: 20° and 40°.
- 100% PureSwitch, compatible with the most popular overdenture systems.
- Includes a transporter.



Screws:

Our screws are the backbone of the Pure Switch concept with an identical geometry to the original ones. This includes the footprint for the original screwdriver tip, the seat angle, diameter, length and metrics, amongst other specifications. Made of Titanium grade V ELI with DLC coating and TIN finish to increase preload at the recommended torque.



Pre-milled:

DESS Pre-milled blank is an excellent choice for your digital projects, with a full assortment of Titanium Grade V ELI (extra low interstitial) and the exclusive Micro Melt Cobalt-Chrome.

- Available in 32 compatibilities.
- Available in Titanium 10mm and 14mm diameter with 20mm millable length.
- Available in CoCr 14mm diameter with 20mm millable length.

CAD/CAM

Pre-milled Blanks:

DESS Pre-milled Blanks are available in Titanium Grade 5 ELI (extra low interstitial) in 10 and 14mm diameter and Micromelt CrCo 14mm diameter. The Micro Melt Cobalt-Chrome alloy has no internal tension, so however radical your design is, the final custom abutment will preserve the shape along the process resulting in a lower probability of ceramic cracks.































A minimal gingival transition height, just 0,3 mm to allow a maximum degree of design freedom.

20 mm millable length makes it one of the longest in the market.

Available compatibilities:

DESS® Has the most comprehensive range of blank premilled, in the market.

 ACTIVE HEX NOBELACTIVE® & NOBELREPLACE® CC	 CONICAL BLX STRAUMANN® BLX	 CONIC OSS OSSTEM® TS	 CONIC MV MIS® V3
 TRI-LOBE NOBELREPLACE SELECT™	 NEO GM NEODENT® GRAND MORSE	 INTERNAL CAM CAMLOG®	 CONIC ANYR MEGAGEN AnyRidge®
 EXTERNAL HEX UNIVERSAL NOBEL BRÄNEMARK®	 INTERNAL HEX USA ZIMMER VIS-VENT®	 INTERNAL CON CONELOG®	 CONIC AXIO ANTHOGRYR AXIOM®
 EXTERNAL HEX USA 3i OSSEOTITE®	 CONIC EVO ASTRA TECH IMPLANT SYSTEM™ EV	 INTERNAL HEX BH BIOHORIZONS® INTERNAL	 CONIC IC MEDENTIS ICX®
 INTERNAL HEX "CLICK" 3i CERTAIN®	 INTERNAL HEX CONIC ASTRA TECH OSSEOSPEED™	 EXTERNAL HEX BH BIOHORIZONS® EXTERNAL	 CONIC DENT DENTIUM SUPERLINE™ & IMPLANTIUM™
 OCTAGON STRAUMANN® SOFT TISSUE LEVEL & synOcta®	 INTERNAL HEX FD DENTSPLY FRIADENT XIVE®	 INTERNAL HEX MI MIS® SEVEN	 INTERNAL SEM BEGO Semados®
 CONICAL BL STRAUMANN® BONE LEVEL	 INTERNAL ANK DENTSPLY ANKYLOS® C/X	 CONIC MC MIS® C1	 CONIC BIO BIOTECH KONTACT®

HOLDERS:

If you have decided to use the DESS® Pre-mills and Blocks systems, and found a holder compatible with your milling machine, then there are different alternatives on how to work on the DESS Digital Workflow. First, we need to define your set-up.

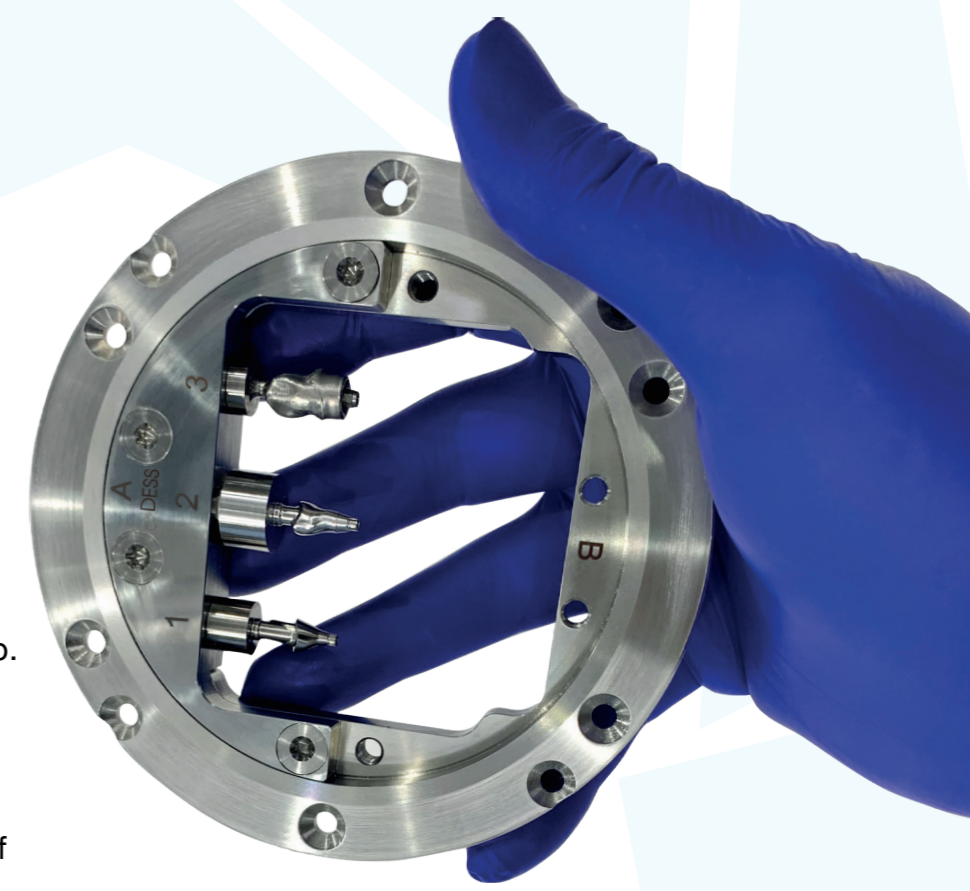

CAM Software:

It is important to know what type of CAM software you're using.

Original CAM*:

If you're using the original CAM software from VHF or Imes, you have to contact the manufacturer or reseller and request the DESS® holder.

If this supplier isn't able to provide you with the holder, you probably will need to pay a "Liberation Fee" that will unlock the software, and will allow you to use our holder.

3rd Party CAM:

If you are already using a different software, you can acquire the holder directly from DESS®.

DENTAL SOFTWARES

hyperDENT

vhf

sum31
DENTAL

MILL
BOX

worknc
Dental

imes-icore
Competence in CNC & DENTAL Solutions

*Please contact your DESS Distributor to get additional information.



Holders:

Standard 98mm Holder:

For most industrial milling machines that have a rounded 98mm disc holder.

What's included in the Box:

- Holder (Outer & Inner holder (A&B)).
- 9 Screws (8 to hold the inner holders, 1 spare).
- 7 Screws (6 to hold blanks to the inner holder, 1 spare).
- 1 Calibration Blanks (blue coloured).
- 1 Hex tool to tighten the screws.

Reference: **HLDSTD**

Holder for Imes-Icore® Machines:

Machines Compatibility:
Coritec 245i touch / Coritec 250i touch .
Coritec 350i / Coritec 350i loader.
Coritec 450i / Coritec 550i.
Coritec 650i / Coritec 650i loader.

What's included in the Box:

- Holder (Outer & Inner holder (A&B)).
- 9 Screws (8 to hold the inner holders, 1 spare).
- 7 Screws (6 to hold blanks to the inner holder, 1 spare).
- 1 Calibration Blanks (blue coloured).
- 1 Hex tool to tighten the screws.

Reference: **HLDIMES**

Holder for VHF® Machines:

Machines Compatibility:
VHF S1 / VHF S2.

What's included in the Box:

- Holder (Outer & Inner holder (A&B)).
- 9 Screws (8 to hold the inner holders, 1 spare).
- 7 Screws (6 to hold blanks to the inner holder, 1 spare).
- 1 Calibration Blanks (blue coloured).
- 1 Hex tool to tighten the screws.

Reference: **HLDVHF**

Holder for VHF® Machines:

Machines Compatibility:
VHF Z4.

What's included in the Box:

- Holder.
- 2 Screws (to hold the holder).
- 3 Screws (1 to hold the blanks to the holder, 2 spares).
- 1 Torx allen tool to tighten the Blanks to the Holder.

Reference: **HLDVHFZ4**

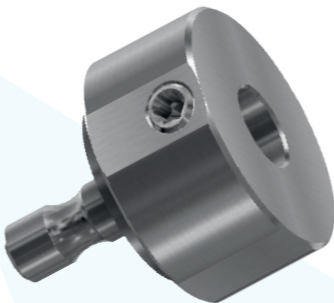

Holder for VHF® Machines:

Machines Compatibility:
VHF R5.

What's included in the Box:

- Holder (Outer & Inner holder (A&B)).
- 9 Screws (8 to hold the inner holders, 1 spare).
- 7 Screws (6 to hold blanks to the inner holder, 1 spare).
- 1 Calibration Blanks (blue coloured).
- 1 Hex tool to tighten the screws.

Reference: **HLDVHFR5**

Holder for VHF® Machines:

Machines Compatibility:
VHF N4.

What's included in the Box:

- Holder .
- 2 Screws (to hold the holder).
- 3 Screws (to hold blanks to the holder).
- 1 Hex tool to tighten the Blanks to the Holder.
- 1 Torx Allen Tool to tighten the Holder.

Reference: **HLDVHFN4**

Holder for Yenadent®:

Machines Compatibility:
D6 / D15 / D43N.

What's included in the Box:

- Holder (Outer & Inner holder (A&B)).
- 9 Screws (8 to hold the inner holders, 1 spare).
- 7 Screws (6 to hold blanks to the inner holder, 1 spare).
- 1 Calibration Blanks (blue coloured).
- 1 Hex tool to tighten the screws.

Reference: **HLDYENA**

Holder for Machines with support changer 3R:

Machines Compatibility:
D14P / DC40 / D43N.

What's included in the Box:

- 1 Holder.
- 25 Screws (20 to hold the blank and 5 spare screws).
- 1 Torx Allen tool to tighten the screws.

Reference: **HLD3R**

AK-1 by ROLAND:

DESS premills are compatible with AK-1 Holder, developed and supplied by ROLAND.

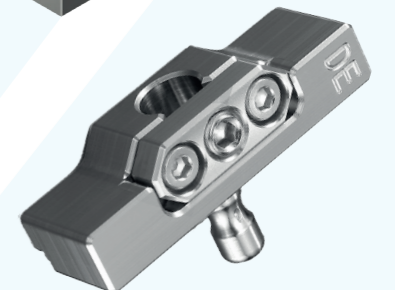
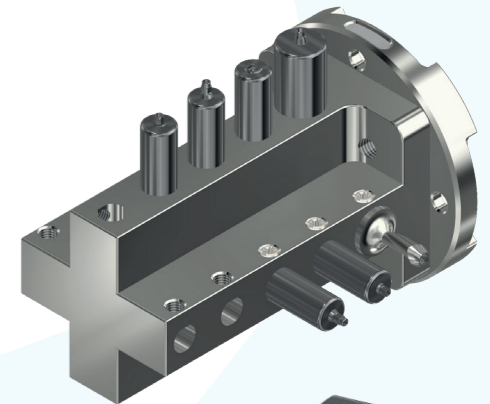
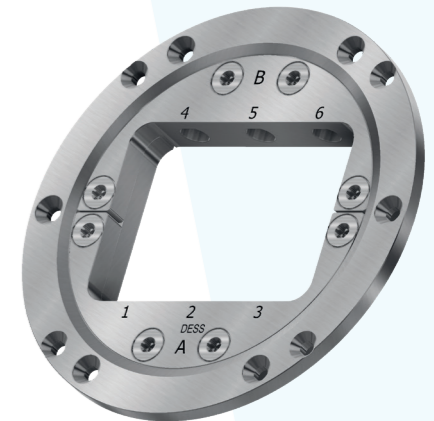
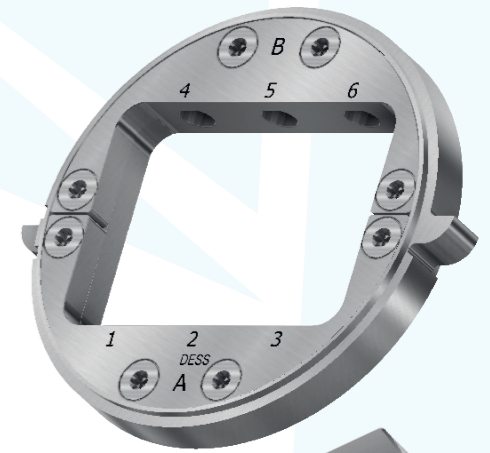

Quick-lock system

How to Install:

1-Unscrew the Pre-mill adapter from the Holder base.
Unscrewing the following THLD screws:

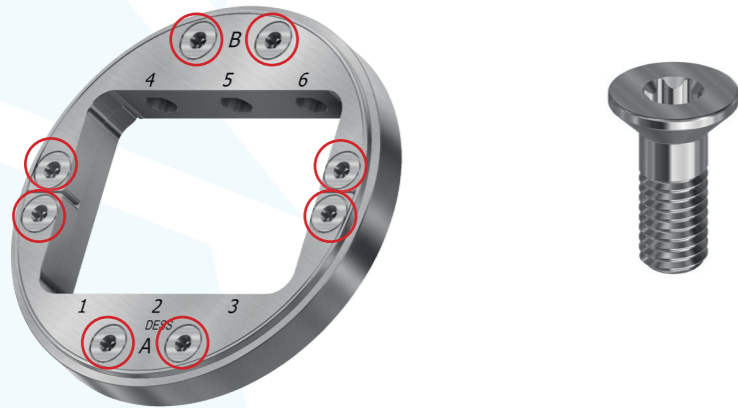

2-Screw the Pre-mill with a TMSV screw, place the flat face with the adapter's flat face.

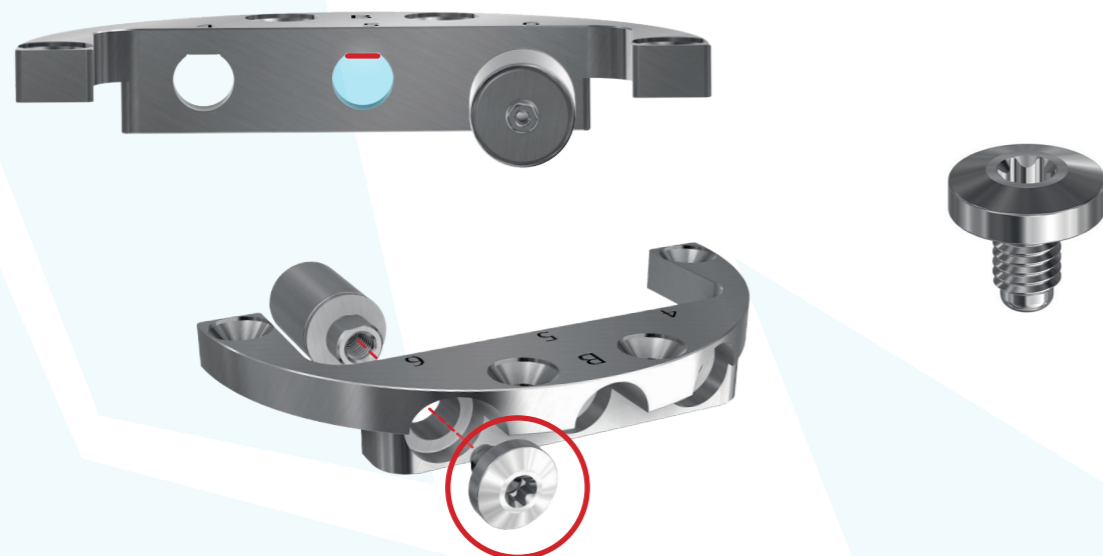

3-Screw back the Pre-mill adapter to the Holder base.

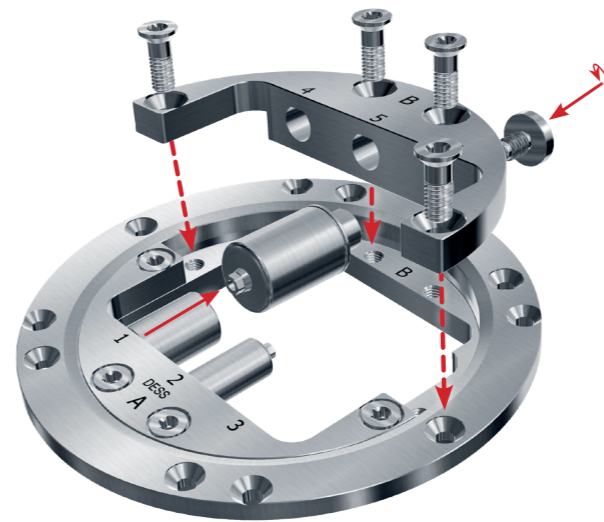

4-Screw the Pre-mill with ESPARRAGOM 5x7'5 screw. Place the flat face of the pre-mill oriented to the bottom to fix it with the clamping screw.

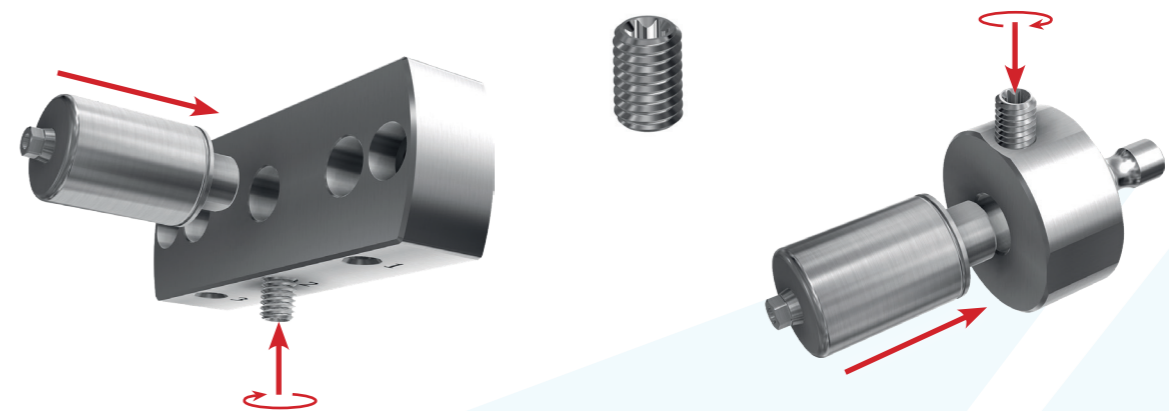



All DESS products are manufactured according to ISO 9001 and ISO 13485 with CE marking for all products Class IIb IIa

All DESS® ANGLEBase® screws and screwdrivers are based on the standard ISO 10664
3i® and 3i Certain®, Miniplant®, MicroMiniplant™ and Osseotite® are registered trademarks of 3i Implant Innovations, USA

ASTRA TECH™, OsseoSpeed™, ANKYLOS® C/X, XiVE®, FRIADENT®, ASTRATECH implant system™ EV and UniAbutment®

Cerec® are registered trademarks of DENTSPLY SIRONA Implants

BioHorizons® is a registered trademark of BioHorizons, INC.

Brånemark System®, NobelReplace® and Replace Select™, NobelActive™, NobelReplace® CC, NobelSpeedy™ and Multi-unit® are registered trademarks of Nobel Biocare AB,

Neodent®, Grand Morse®, Straumann® and synOcta® are registered trademarks of Straumann Holding AG, Switzerland

MIS® is a registered trademark of MIS Implant Technologies Ltd.

Zimmer Screw-Vent® and SwissPlus® are registered trademarks of Zimmer Dental INC, USA

Dyna® is a registered trademark of Dyna Dental Engineering BV

Locator® is a registered trademark of ZEST IP Holdings

Camlog® and Conelog® are registered trademarks of CAMLOG Biotechnologies AG

Megagen® is a registered trademark of MEGAGEN IMPLANT CO. LTD

Torx is a trademark of ACUMENT INTELLECTUAL PROPERTIES, LLC

Bego Semados® is a registered trademark of BEGO GmbH & Co. KG

Anthogyr® is a registered trademark of Anthogyr SAS

Medentis ICX® is a registered trademark of medentis medical GmbH

Osstem®, Hiossen® is a registered trademark of OSSTEM IMPLANT CO. LTD

Dentium® is a trademark of Dentium Co. Ltd.

GOBALD® is a trademark of Global D SASU.

Biotech Kontakt® is a trademark Biotech Dental SAS.

BTI® is a trademark BTI Biotechnology Institute.

PHIBO® is a trademark PHIBO Dental Solutions S.L.

DESS products can be used only by licensed dentists, physicians and labs.

Please refer ever to the instructions for use available on the website

www.dess-usa.com

or supplied with the product.

Some products may not be available in your country. Some of the products are cleared for US and Canada.

Please contact your local distributor for more details.



Health Canada
Medical Device Licenses
94512 & 107023





www.dess-usa.com